

**TOP VIEW  
(COVER REMOVED)**

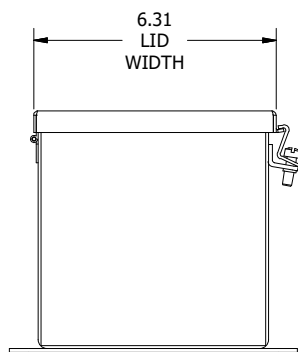

**LEFT SIDE VIEW**

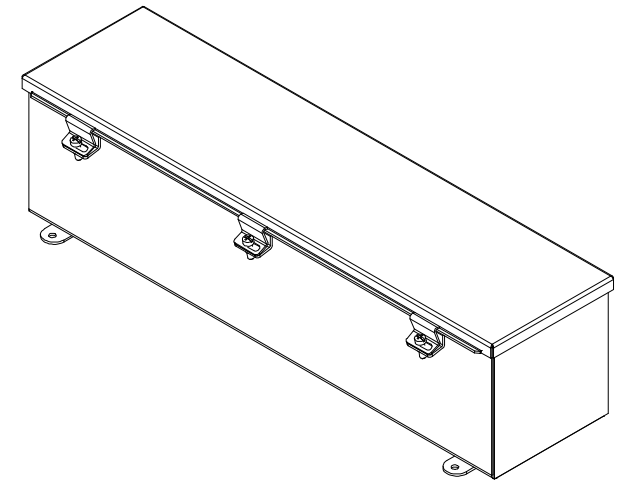
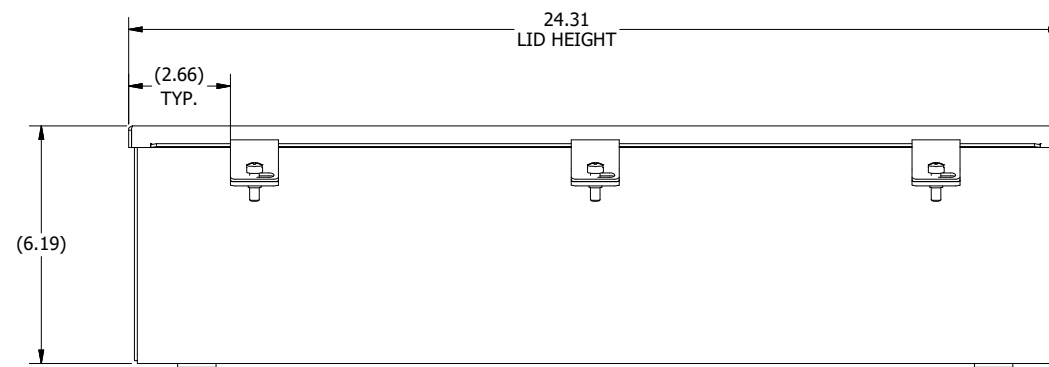

**FRONT VIEW**

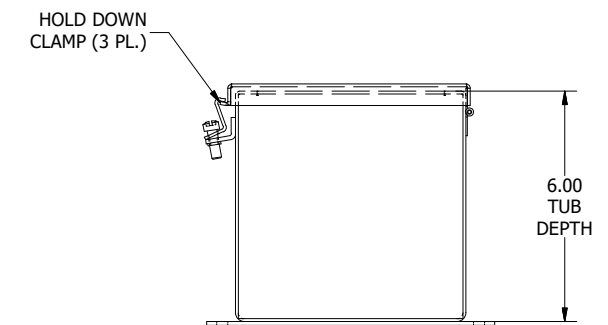

**RIGHT SIDE VIEW**

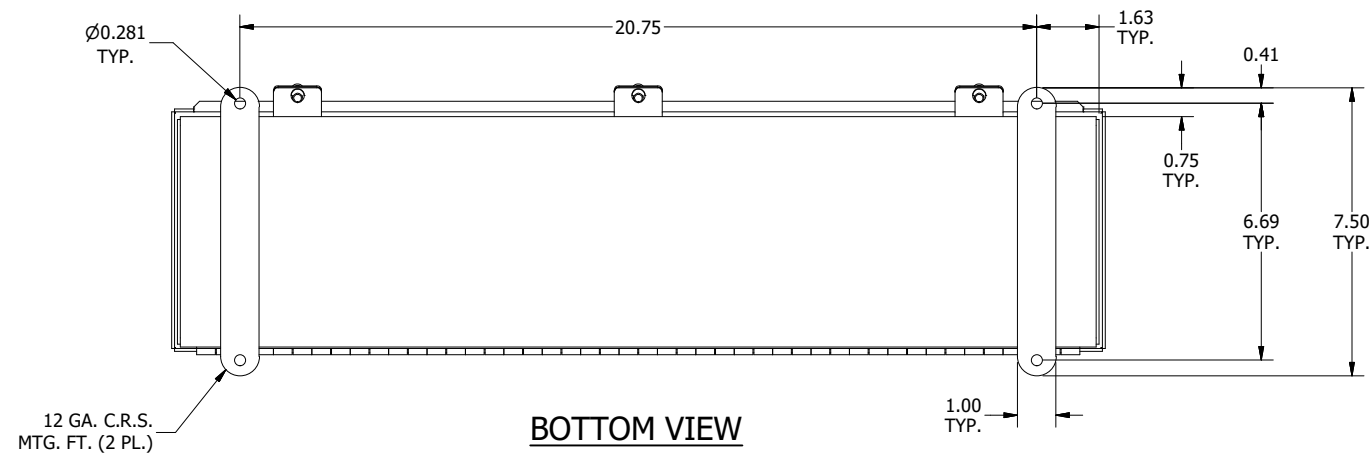

**BOTTOM VIEW**

**PART #:T6624CH**  
**(DATA SUBJECT TO CHANGE WITHOUT NOTICE)**  
**THIS DRAWING IS THE PROPERTY OF HUBBELL INC. WIEGMANN**  
**ALL INFORMATION IS PROPRIETARY AND NOT TO BE DUPLICATED**