

**VIEW B-B
(LID ASSM. REMOVED)**

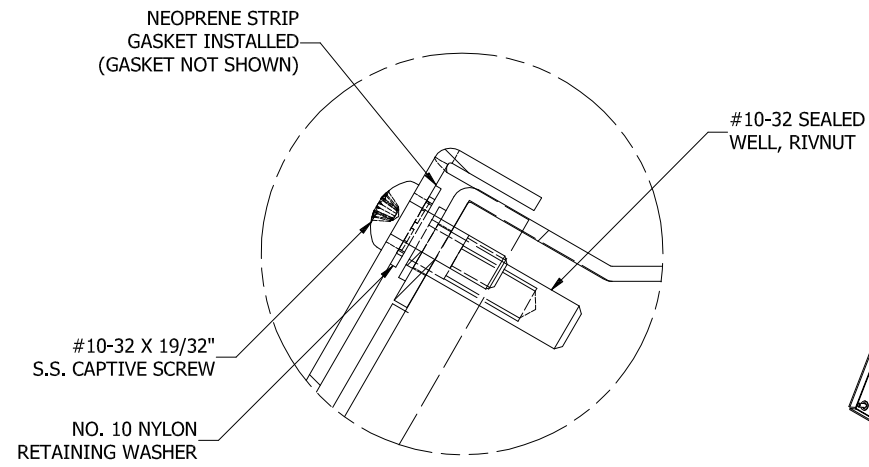

**DETAIL A (3 PL.)
(LID ATTACHMENT DEATIL)**

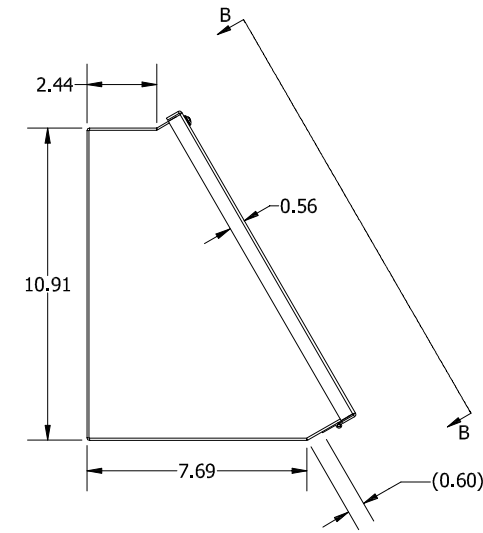
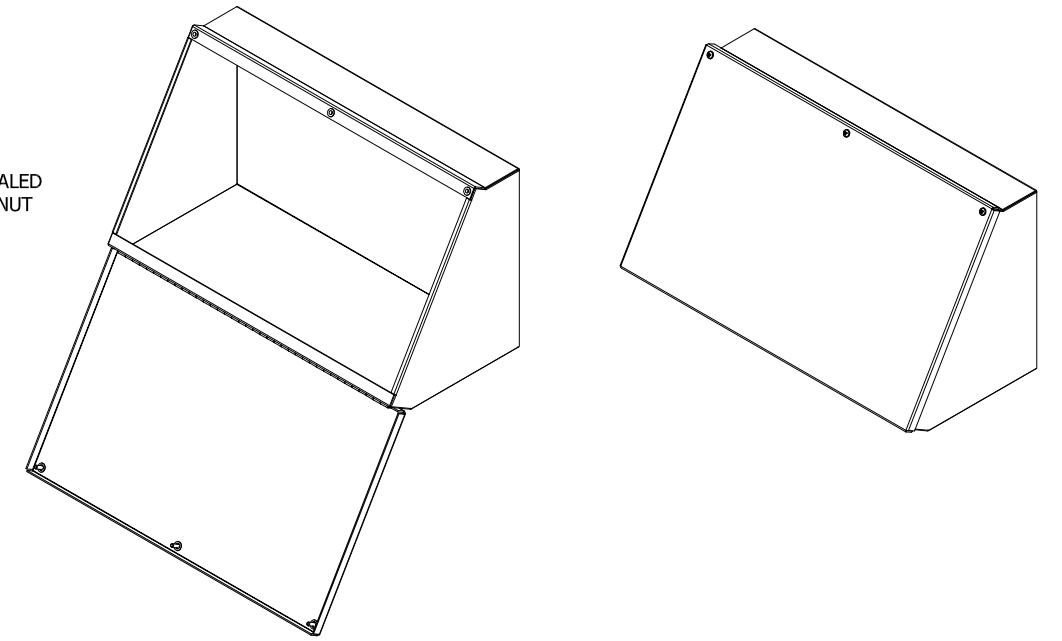

LEFT SIDE VIEW

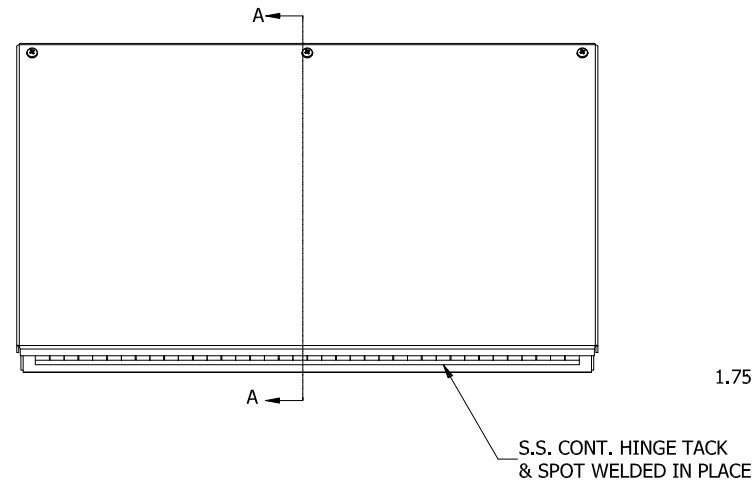

FRONT VIEW

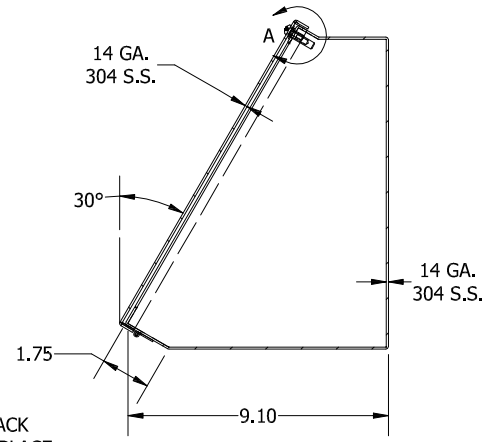

**SECTION A-A VIEW
(INSIDE LEFT OF ENCL.)**

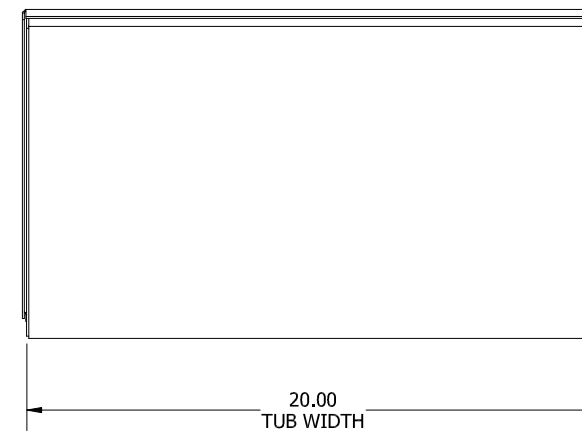

BOTTOM VIEW

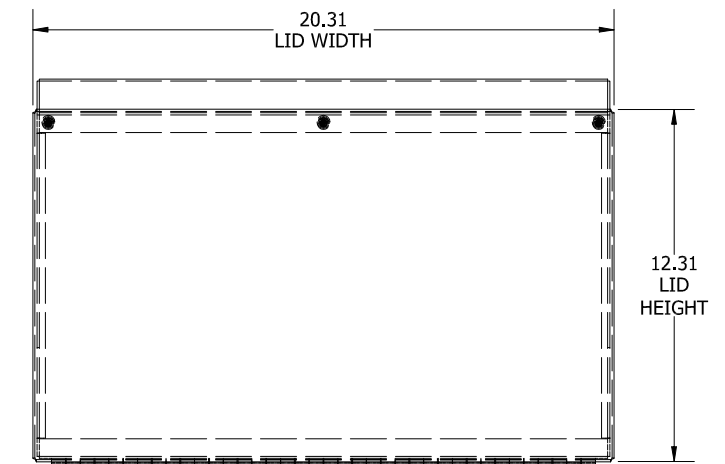

**SECTION B-B
(STRAIGHT AHEAD VIEW OF LID)**

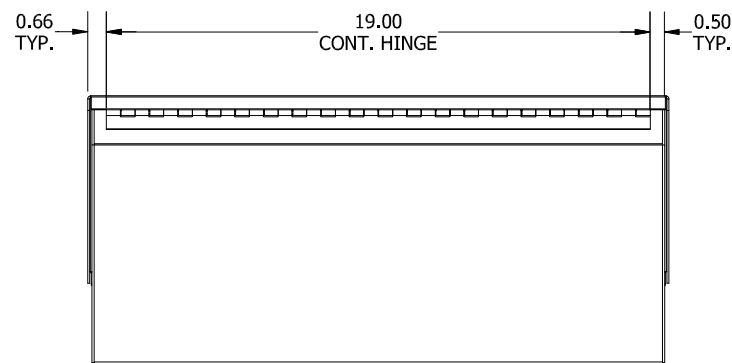

REAR VIEW

PART#: WC12C20SS
(DATA SUBJECT TO CHANGE WITHOUT NOTICE)

THIS DRAWING IS PROPERTY OF HUBBELL INC. WIEGMANN
ALL INFORMATION IS PROPRIETARY AND NOT TO BE DUPLICATED