

**VIEW B-B  
(LID ASSM. REMOVED)**

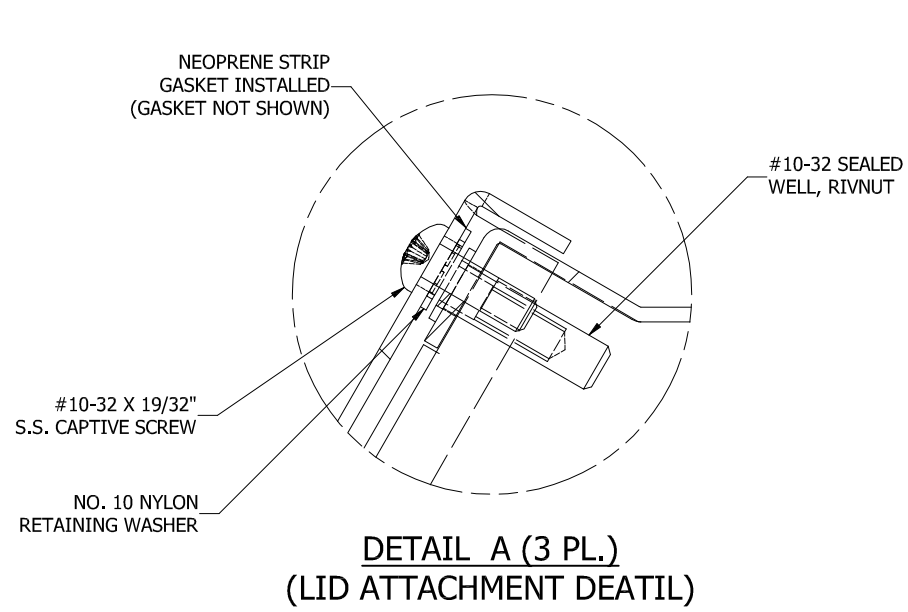

**DETAIL A (3 PL.)  
(LID ATTACHMENT DETAIL)**

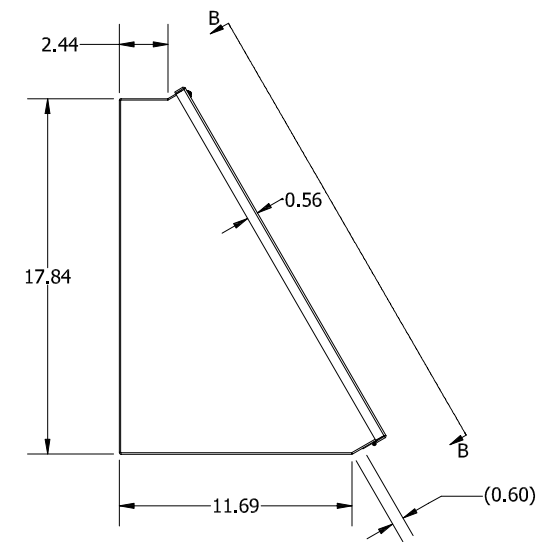
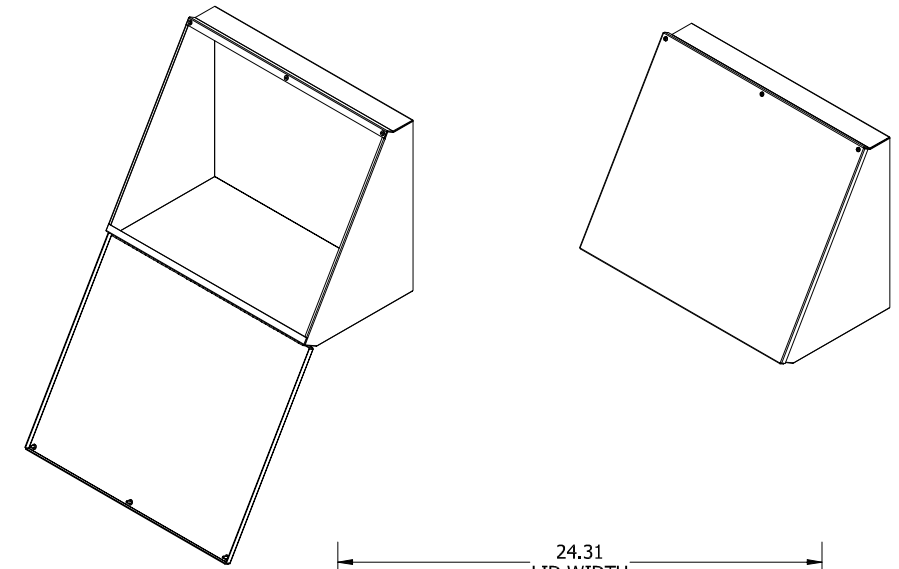

**LEFT SIDE VIEW**

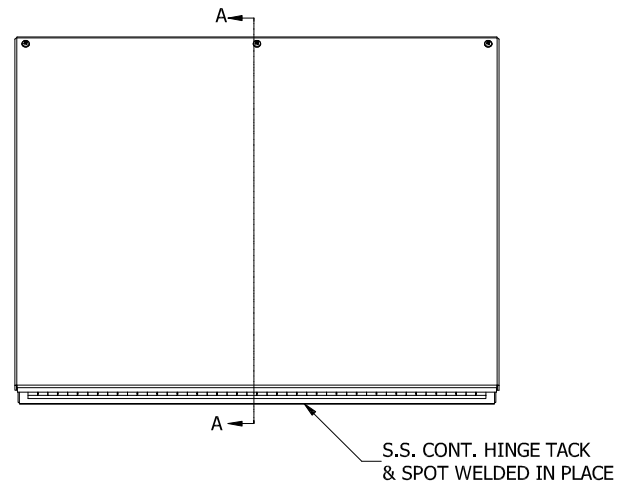

**FRONT VIEW**

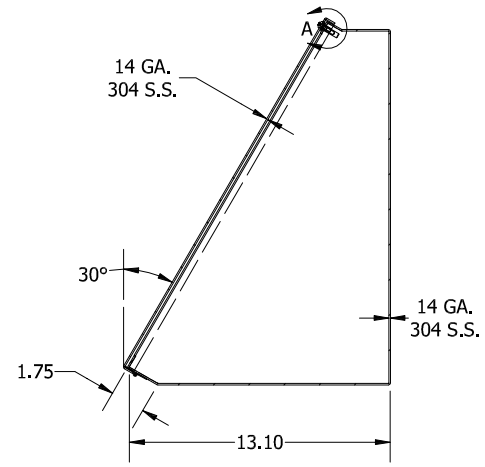

**SECTION A-A VIEW  
(INSIDE LEFT OF ENCL.)**

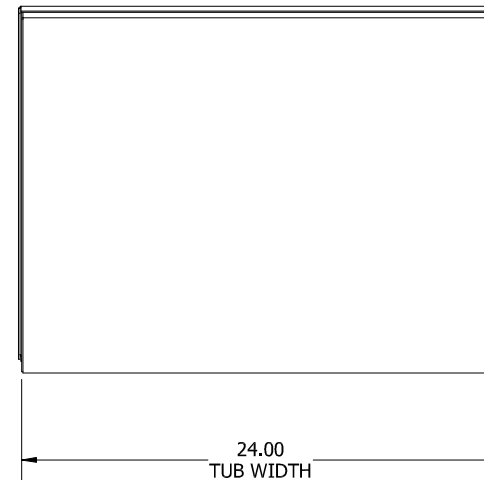

**BOTTOM VIEW**

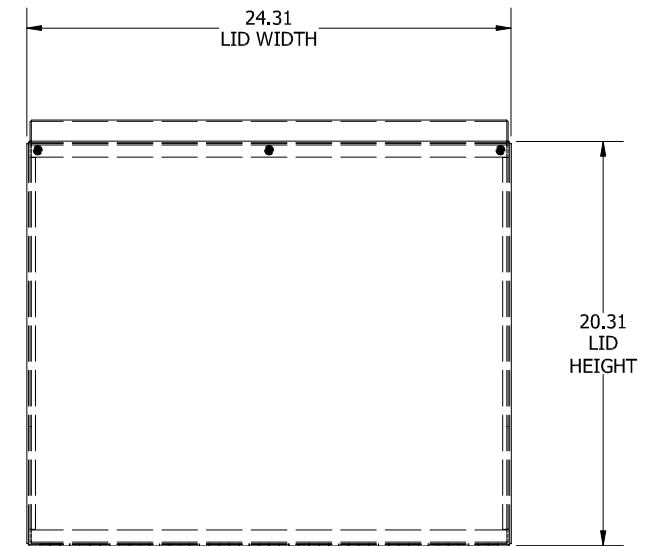

**SECTION B-B  
(STRAIGHT AHEAD VIEW OF LID)**

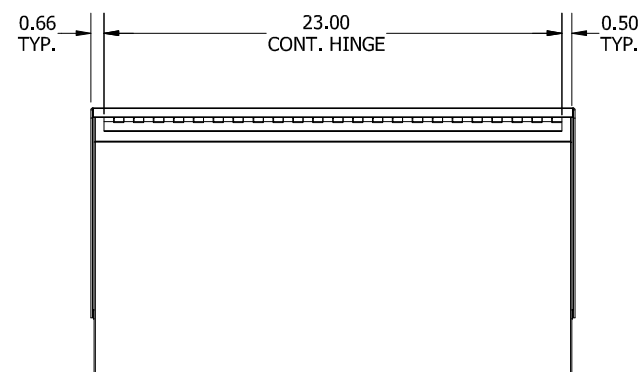

**REAR VIEW**

PART#: WC20C24SS  
(DATA SUBJECT TO CHANGE WITHOUT NOTICE)

THIS DRAWING IS PROPERTY OF HUBBELL INC. WIEGMANN  
ALL INFORMATION IS PROPRIETARY AND NOT TO BE DUPLICATED