

M-12624

4

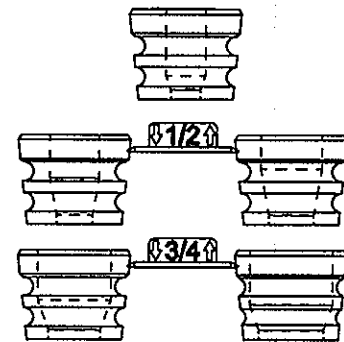
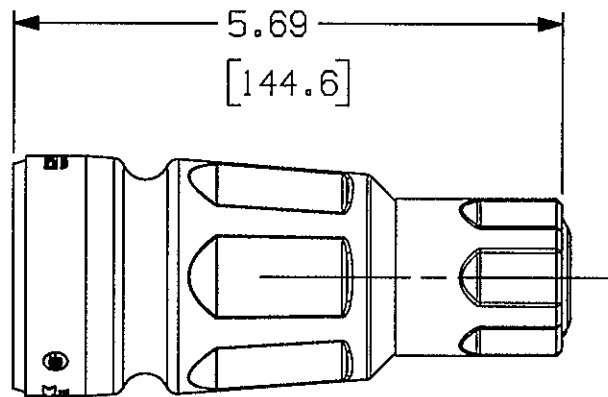
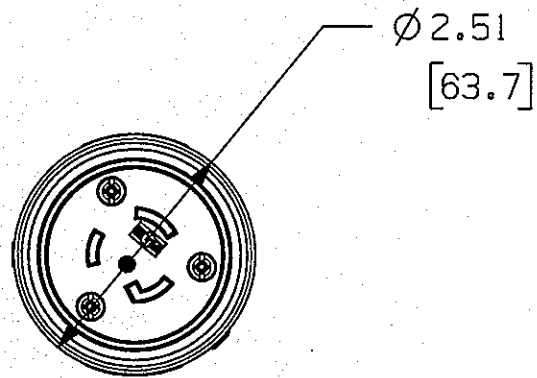

BUSHINGS

NOTES:

1. DIMENSIONS SHOWN ARE TYPICAL. DIMENSION UNITS: INCHES [mm].
2. DEVICES ARE UL LISTED PER UL 498.
3. DEVICES ARE CSA CERTIFIED PER CSA C22.2 NO.42.
4. DEVICES ARE UL VERIFIED WITH THE CONSTRUCTION & PERFORMANCE REQUIREMENTS OF FEDERAL SPECIFICATION W-C-596H EXCEPT HBL27W08.
5. FIVE STRAIN RELIEF BUSHINGS ACCOMMODATE ROUND CORD TYPES S & SJ
 $\phi 0.325"$ TO $\phi 0.875"$, ($\phi 8.3$ mm TO $\phi 22.2$ mm):
 3-WIRE DEVICES: 16/3 SJ TO 10/3 SJ, 18/3 S TO 10/3 S
 4-WIRE DEVICES: 18/4 SJ TO 10/4 SJ, 18/4 S TO 10/4 S
 5-WIRE DEVICES: 18/5 S TO 10/5 S
6. CERTAIN DEVICES AVAILABLE IN BLACK.
7. THIS PRODUCT HAS BEEN TESTED TO NEMA ENCLOSURE TYPES 3R, 3RX, 4, 4X, 6, 6P, 12 AND IEC CLASSIFICATION IP67 WHEN THE CLOSURE CAP IS CLOSED OR WHEN MATED WITH AN EQUIVALENT RATED WATERTIGHT DEVICE.
 WARNING! RISK OF ELECTRICAL SHOCK. DO NOT SUBMERGE.
 THE ENCLOSURE RATINGS 6, 6P & IP67 OF THIS PRODUCT ARE ONLY INTENDED TO DEMONSTRATE SUPERIOR RESISTANCE TO WATER INGRESS AND NOT FOR SUBMERSION.

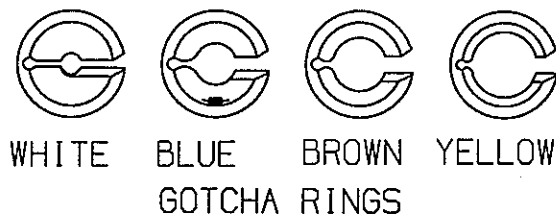

WHITE BLUE BROWN YELLOW
GOTCHA RINGS

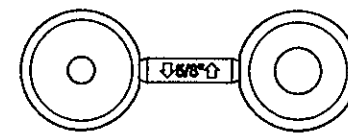

CONE SEALS

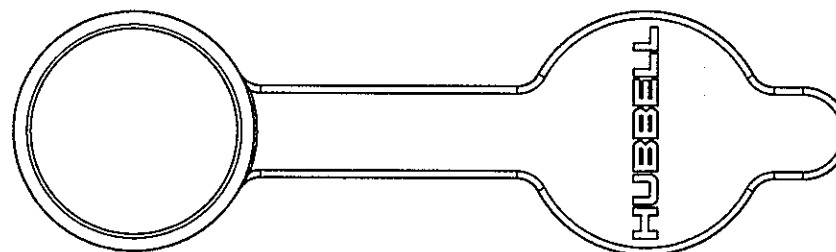

CONNECTOR SEALING CAP

CATALOG NO.	HBL27W47	HBL27W48	HBL27W49
NEMA CONFIG			
	L5-20R	L6-20R	L7-20R
RATING	20A, 125V	20A, 250V	20A, 277VAC
POLES/WIRES	2P/3W GROUNDING	2P/3W GROUNDING	2P/3W GROUNDING

CATALOG NO.	HBL27W74	HBL27W75	HBL27W76	HBL27W81	HBL27W82	HBL27W83	HBL27W08
NEMA CONFIG							
	L14-20R	L15-20R	L16-20R	L21-20R	L22-20R	L23-20R	NON-NEMA
RATING	20A, 125/250V	20A, 3 ϕ 250V	20A, 3 ϕ 480V	20A, 3 ϕ Y 120/208V AC	20A, 3 ϕ Y 277/480V AC	20A, 3 ϕ Y 347/600V AC	20A, 125/250V
POLES/WIRES	3P/4W GROUNDING	3P/4W GROUNDING	3P/4W GROUNDING	4P/5W GROUNDING	4P/5W GROUNDING	4P/5W GROUNDING	3P/3W NON-GROUNDING

CODE 74545

LIST OF PARTS

DESCRIPTION	MATERIAL	FINISH
CONNECTOR FACE	NYLON	WHITE
TERMINAL COVER	POLYCARB.	CLEAR
CONTACTS	BRASS	NICKEL
TERMINAL SCREWS	BRASS	NONE/NICKEL/GREEN
ASSEMBLY SCREWS	SS	
SHELL BODY	TPE	YELLOW/BLACK
SHELL INSERT	NYLON	NATURAL
NUT	PBT	GRAY/BLACK
BUSHINGS	ELASTOMER	BLACK
GOTCHA RING	NYLON	
CONE SEAL	ELASTOMER	BLACK
SEALING CAP	TPE	YELLOW/BLACK

CATALOG NO. HBL27W76
(NOT SHOWN TO SCALE)

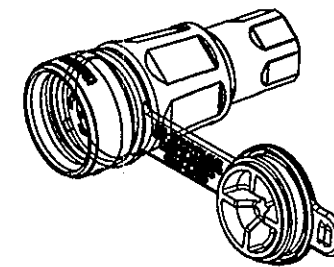

4	LIST OF PARTS FINISH GRAY/BLACK WAS GRAY. PER DCN 21968 SPN	DJP	3/8/16
3	ADDED ISO VIEW TO INDICATE SOLID MODEL DRAWING PER DCN 21895 DDL	DJP	02/26/16
2	REVISED NOTES, PART NO'S & LIST OF PARTS PER DCN 20803 MAM	TLS	10/27/2014
1	INITIAL RELEASE PER DCN 20391 WRV	TLS	06/2014
SYM	REVISIONS	APP	DATE

THE DESIGN AND DIMENSIONS OF THE PRODUCT SHOWN ON THIS DRAWING ARE SUBJECT TO CHANGE WITHOUT NOTICE

TITLE
WATERTIGHT CONNECTOR
CUSTOMER DRAWING

TOLERANCES UNLESS OTHERWISE SPECIFIED

.XX = $\pm .01$
.XXX = $\pm .005$
ANGLES = $\pm 2^\circ$

WIRING DEVICE-KELLEMS
HUBBELL INCORPORATED
SHELTON, CT

DR. BY WRV APP. BY TLS
TR. BY SCALE 1:2
CHK. BY TLS DATE 06/2014

DIMENSION SHEET FOR CAT. NO.

SEE TABLE

REPAIRABLE

NON-REPAIRABLE

B

M-12624

4