

M-13560

1

2C USB PORT DEVICE SERIES

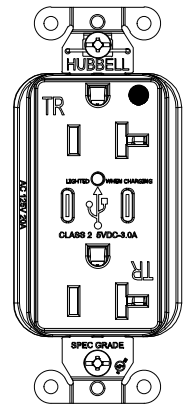

20A HOSPITAL GRADE DEVICE

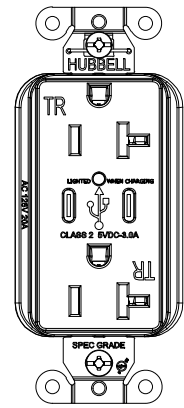

20A STANDARD GRADE DEVICE

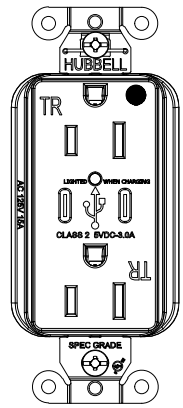

15A HOSPITAL GRADE DEVICE

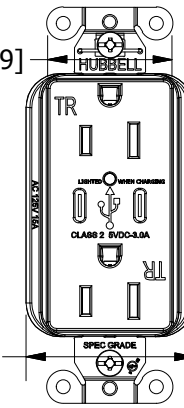

15A STANDARD GRADE DEVICE

AC USB PORT DEVICE SERIES

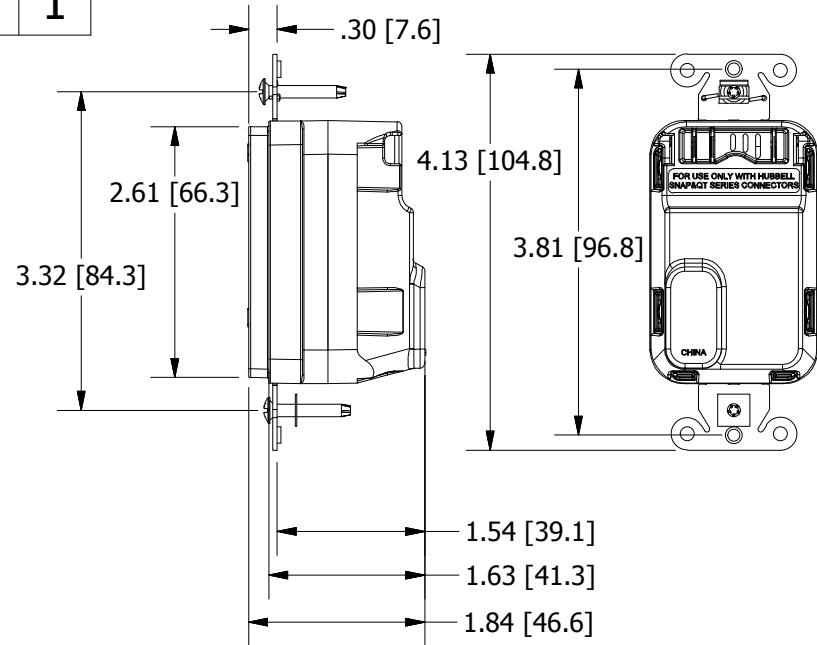
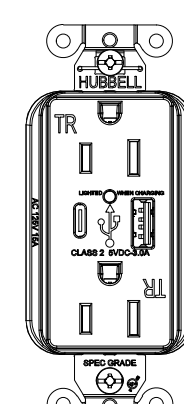
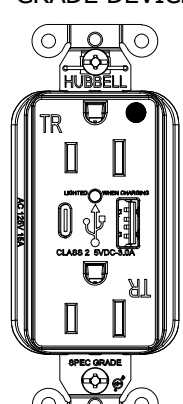
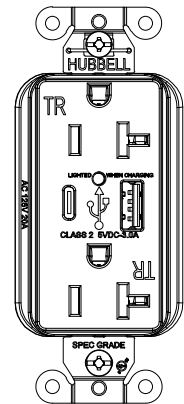
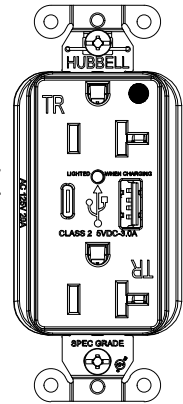

LIST OF PARTS

DESCRIPTION	MATERIAL	FINISH
COVER	THERMOPLASTIC	
BASE	THERMOPLASTIC	
MIDDLE HOUSING	THERMOPLASTIC	
SHUTTER	THERMOPLASTIC	
STRAP	GALVANIZED STEEL	
MOUNTING SCREW	STEEL	ZINC PLATED
WASHER	THERMOPLASTIC	
GR SPRING WIRE	STAINLESS STEEL	
GR TERMINAL	BRASS	
MAIN TERMINAL	COPPER ALLOY	
SNAP CONTACTS	COPPER ALLOY	SILVER PLATED
USB PORT	STAINLESS STEEL	

NOTE:

1. BASE COLOR: BLACK; COVER COLOR SEE TABLE PER CATALOG.
2. RATING/TYPE: RECEPTACLE: SEE TABLE. USB CHARGER PORT OUTPUT: 5VDC 3A MAX.
3. FOR CONNECTION USE WITH CAT.# SNAP1RA, SNAP2RA, SNAP1RNA, SANP2RNA, QT1RA OR QT2RA
4. ALL DIMENSIONS ARE IN INCHES [mm].

CODE 74545

2C USB PORT DEVICE SERIES			AC USB PORT DEVICE SERIES			RATING
CATALOG NO:	COLOR:	DESCRIPTION	CATALOG NO:	COLOR:	DESCRIPTION	
SNAP15UC	BROWN	USB CHARGER 2C PORT SNAP CONNECT 15A 125V DUP TR RCPT	SNAP15UAC	BROWN	USB CHARGER AC PORT SNAP CONNECT 15A 125V DUP TR RCPT	15A 125V
SNAP15UCI	IVORY		SNAP15UACI	IVORY		
SNAP15UCW	WHITE		SNAP15UACW	WHITE		
SNAP15UCLA	LIGHT ALMOND		SNAP15UACLA	LIGHT ALMOND		
SNAP15UCGY	GRAY		SNAP15UACGY	GRAY		
SNAP15UCBK	BLACK		SNAP15UACBK	BLACK		
SNAP20UC	BROWN	USB CHARGER 2C PORT SNAP CONNECT 20A 125V DUP TR RCPT	SNAP20UAC	BROWN	USB CHARGER AC PORT SNAP CONNECT 20A 125V DUP TR RCPT	20A 125V
SNAP20UCI	IVORY		SNAP20UACI	IVORY		
SNAP20UCW	WHITE		SNAP20UACW	WHITE		
SNAP20UCLA	LIGHT ALMOND		SNAP20UACLA	LIGHT ALMOND		
SNAP20UCGY	GRAY		SNAP20UACGY	GRAY		
SNAP20UCBK	BLACK		SNAP20UACBK	BLACK		
SNAP8200UC	BROWN	USB CHARGER 2C PORT SNAP CONNECT 15A 125V HG DUP TR RCPT	SNAP8200UAC	BROWN	USB CHARGER AC PORT SNAP CONNECT 15A 125V HG DUP TR RCPT	15A 125V
SNAP8200UCI	IVORY		SNAP8200UACI	IVORY		
SNAP8200UCW	WHITE		SNAP8200UACW	WHITE		
SNAP8200UCLA	LIGHT ALMOND		SNAP8200UACLA	LIGHT ALMOND		
SNAP8200UCGY	GRAY		SNAP8200UACGY	GRAY		
SNAP8200UCBK	BLACK		SNAP8200UACBK	BLACK		
SNAP8300UC	BROWN	USB CHARGER 2C PORT SNAP CONNECT 20A 125V HG DUP TR RCPT	SNAP8300UAC	BROWN	USB CHARGER AC PORT SNAP CONNECT 20A 125V HG DUP TR RCPT	20A 125V
SNAP8300UCI	IVORY		SNAP8300UACI	IVORY		
SNAP8300UCW	WHITE		SNAP8300UACW	WHITE		
SNAP8300UCLA	LIGHT ALMOND		SNAP8300UACLA	LIGHT ALMOND		
SNAP8300UCGY	GRAY		SNAP8300UACGY	GRAY		
SNAP8300UCBK	BLACK		SNAP8300UACBK	BLACK		
SNAP8300UCR	RED		SNAP8300UACR	RED		

1	NEW RELEASE PER DCN #23336. D.LI		2017.9.19
REV	DESCRIPTION	APP	DATE

THE DESIGN AND DIMENSIONS OF THE PRODUCT SHOWN ON THIS DRAWING ARE SUBJECT TO CHANGE WITHOUT NOTICE

TITLE
SNAPCONNECT AC & 2C USB PORT TR RECEPTACLE

TOLERANCES UNLESS OTHERWISE SPECIFIED	WIRING DEVICE-KELLEMS HUBBELL INCORPORATED SHELTON, CT		
.XX = ± .01	DR. BY	N.H	APP. BY
.XXX = ± .005	TR. BY		SCALE 1:2
ANGLES = ± 2'	CHK. BY	MAP	DATE 2017.9.18

DIMENSION SHEET FOR CAT. NO.

SEE TABLE

REPAIRABLE

NON-REPAIRABLE

B

M-13560

1