

M-14078

1

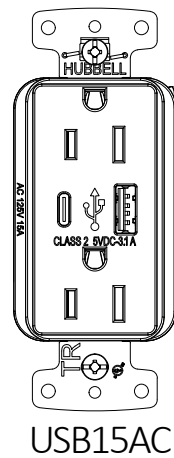

USB15A

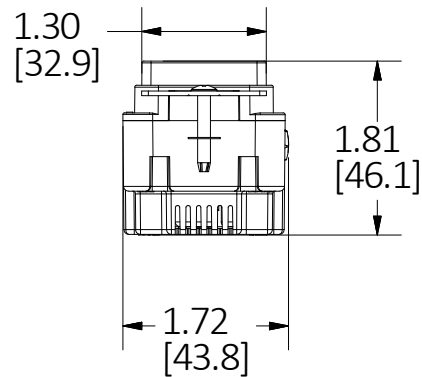
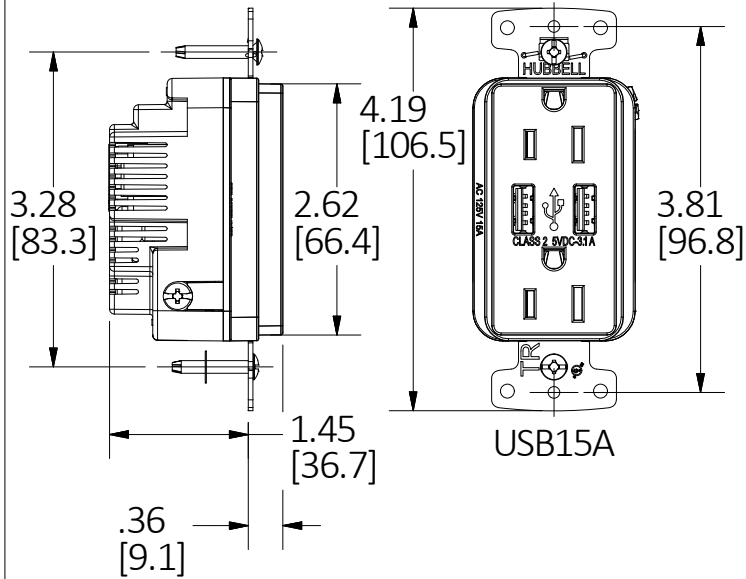
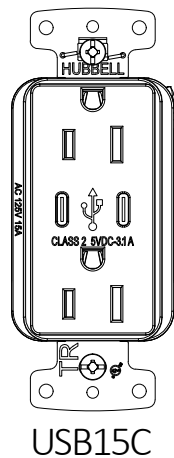

USB15AC

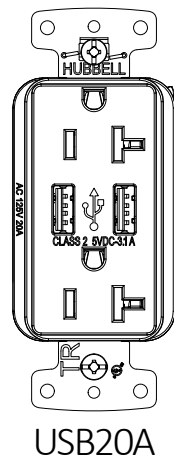

USB15C

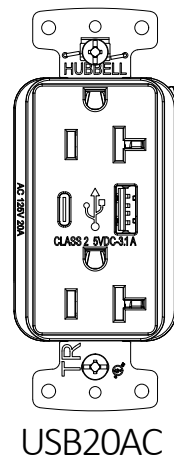

USB20A

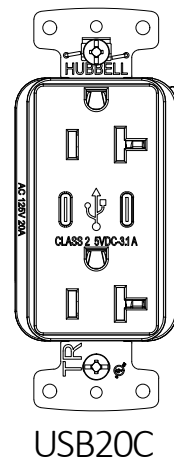

USB20AC

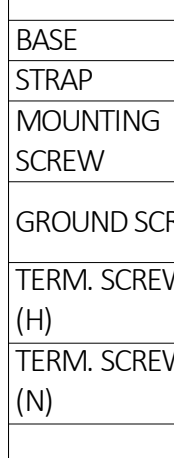

USB20C

CATALOG	DESCRIPTION	COLOR	RCPT RATING
USB15A	15A DUPLEX TR RCPT W/ (2) TYPE A USB CHARGING PORTS, BR	BROWN	15A 125VAC
USB15AI	15A DUPLEX TR RCPT W/ (2) TYPE A USB CHARGING PORTS, IV	IVORY	15A 125VAC
USB15AW	15A DUPLEX TR RCPT W/ (2) TYPE A USB CHARGING PORTS, WH	WHITE	15A 125VAC
USB15ALA	15A DUPLEX TR RCPT W/ (2) TYPE A USB CHARGING PORTS, LA	LIGHT ALMOND	15A 125VAC
USB15AGY	15A DUPLEX TR RCPT W/ (2) TYPE A USB CHARGING PORTS, GY	GRAY	15A 125VAC
USB15ABK	15A DUPLEX TR RCPT W/ (2) TYPE A USB CHARGING PORTS, BK	BLACK	15A 125VAC
USB15AC	15A DUPLEX TR RCPT W/ (1) A AND (1) C USB CHARGING PORTS, BR	BROWN	15A 125VAC
USB15ACI	15A DUPLEX TR RCPT W/ (1) A AND (1) C USB CHARGING PORTS, IV	IVORY	15A 125VAC
USB15ACW	15A DUPLEX TR RCPT W/ (1) A AND (1) C USB CHARGING PORTS, WH	WHITE	15A 125VAC
USB15ACLA	15A DUPLEX TR RCPT W/ (1) A AND (1) C USB CHARGING PORTS, LA	LIGHT ALMOND	15A 125VAC
USB15ACGY	15A DUPLEX TR RCPT W/ (1) A AND (1) C USB CHARGING PORTS, GY	GRAY	15A 125VAC
USB15ACBK	15A DUPLEX TR RCPT W/ (1) A AND (1) C USB CHARGING PORTS, BK	BLACK	15A 125VAC
USB15C	15A DUPLEX TR RCPT W/ (2) TYPE C USB CHARGING PORTS, BR	BROWN	15A 125VAC
USB15CI	15A DUPLEX TR RCPT W/ (2) TYPE C USB CHARGING PORTS, IV	IVORY	15A 125VAC
USB15CW	15A DUPLEX TR RCPT W/ (2) TYPE C USB CHARGING PORTS, WH	WHITE	15A 125VAC
USB15CLA	15A DUPLEX TR RCPT W/ (2) TYPE C USB CHARGING PORTS, LA	LIGHT ALMOND	15A 125VAC
USB15CGY	15A DUPLEX TR RCPT W/ (2) TYPE C USB CHARGING PORTS, GY	GRAY	15A 125VAC
USB15CBK	15A DUPLEX TR RCPT W/ (2) TYPE C USB CHARGING PORTS, BK	BLACK	15A 125VAC
USB20A	20A DUPLEX TR RCPT W/ (2) TYPE A USB CHARGING PORTS, BR	BROWN	20A 125VAC
USB20AI	20A DUPLEX TR RCPT W/ (2) TYPE A USB CHARGING PORTS, IV	IVORY	20A 125VAC
USB20AW	20A DUPLEX TR RCPT W/ (2) TYPE A USB CHARGING PORTS, WH	WHITE	20A 125VAC
USB20ALA	20A DUPLEX TR RCPT W/ (2) TYPE A USB CHARGING PORTS, LA	LIGHT ALMOND	20A 125VAC
USB20AGY	20A DUPLEX TR RCPT W/ (2) TYPE A USB CHARGING PORTS, GY	GRAY	20A 125VAC
USB20ABK	20A DUPLEX TR RCPT W/ (2) TYPE A USB CHARGING PORTS, BK	BLACK	20A 125VAC
USB20AC	20A DUPLEX TR RCPT W/ (1) A AND (1) C USB CHARGING PORTS, BR	BROWN	20A 125VAC
USB20ACI	20A DUPLEX TR RCPT W/ (1) A AND (1) C USB CHARGING PORTS, IV	IVORY	20A 125VAC
USB20ACW	20A DUPLEX TR RCPT W/ (1) A AND (1) C USB CHARGING PORTS, WH	WHITE	20A 125VAC
USB20ACLA	20A DUPLEX TR RCPT W/ (1) A AND (1) C USB CHARGING PORTS, LA	LIGHT ALMOND	20A 125VAC
USB20ACGY	20A DUPLEX TR RCPT W/ (1) A AND (1) C USB CHARGING PORTS, GY	GRAY	20A 125VAC
USB20ACBK	20A DUPLEX TR RCPT W/ (1) A AND (1) C USB CHARGING PORTS, BK	BLACK	20A 125VAC
USB20C	20A DUPLEX TR RCPT W/ (2) TYPE C USB CHARGING PORTS, BR	BROWN	20A 125VAC
USB20CI	20A DUPLEX TR RCPT W/ (2) TYPE C USB CHARGING PORTS, IV	IVORY	20A 125VAC
USB20CW	20A DUPLEX TR RCPT W/ (2) TYPE C USB CHARGING PORTS, WH	WHITE	20A 125VAC
USB20CLA	20A DUPLEX TR RCPT W/ (2) TYPE C USB CHARGING PORTS, LA	LIGHT ALMOND	20A 125VAC
USB20CGY	20A DUPLEX TR RCPT W/ (2) TYPE C USB CHARGING PORTS, GY	GRAY	20A 125VAC
USB20CBK	20A DUPLEX TR RCPT W/ (2) TYPE C USB CHARGING PORTS, BK	BLACK	20A 125VAC

NOTES:  
 1. USB CHARGER OUT PUT: 5VDC 3.1A.  
 2. ALL DIMENSIONS ARE IN INCHES [mm].

CAGE CODE 74545

LIST OF PARTS

DESCRIPTION	MATERIAL	FINISH
COVER	THERMOPLASTIC	COLOR PER CAT.#
BASE	THERMOPLASTIC	BLACK
STRAP	GALV. STEEL	
MOUNTING SCREW	STEEL	Zn PLATE
GROUND SCREW	STEEL	Zn PLATE + GREEN DYE
TERM. SCREW (H)	STEEL	BRASS PLATE
TERM. SCREW (N)	STEEL	NICKEL PLATE

1	NEW RELEASE PER DCN #190702070510. D.LI		6/25/19
REV	DESCRIPTION	APP	DATE

THE DESIGN AND DIMENSIONS OF THE PRODUCT SHOWN ON THIS DRAWING ARE SUBJECT TO CHANGE WITHOUT NOTICE. DIMENSIONS ARE IN INCHES [mm].

TITLE  
 RESI DUPLEX TR RECEPTACLE W/USB CHARGER

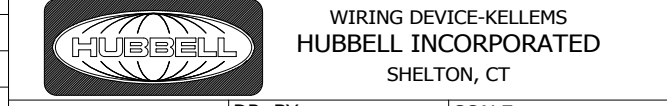

TOLERANCES UNLESS OTHERWISE SPECIFIED .XX = ± .01 .XXX = ± .005 ANGLE TOL. ±2°	DR. BY D.LI	SCALE 1/2
	CHK. BY	DATE 6/25/19

DIMENSION SHEET FOR CAT. NO. SEE TABLE

**B**

**M-14078**

**1**