

M-9959 1

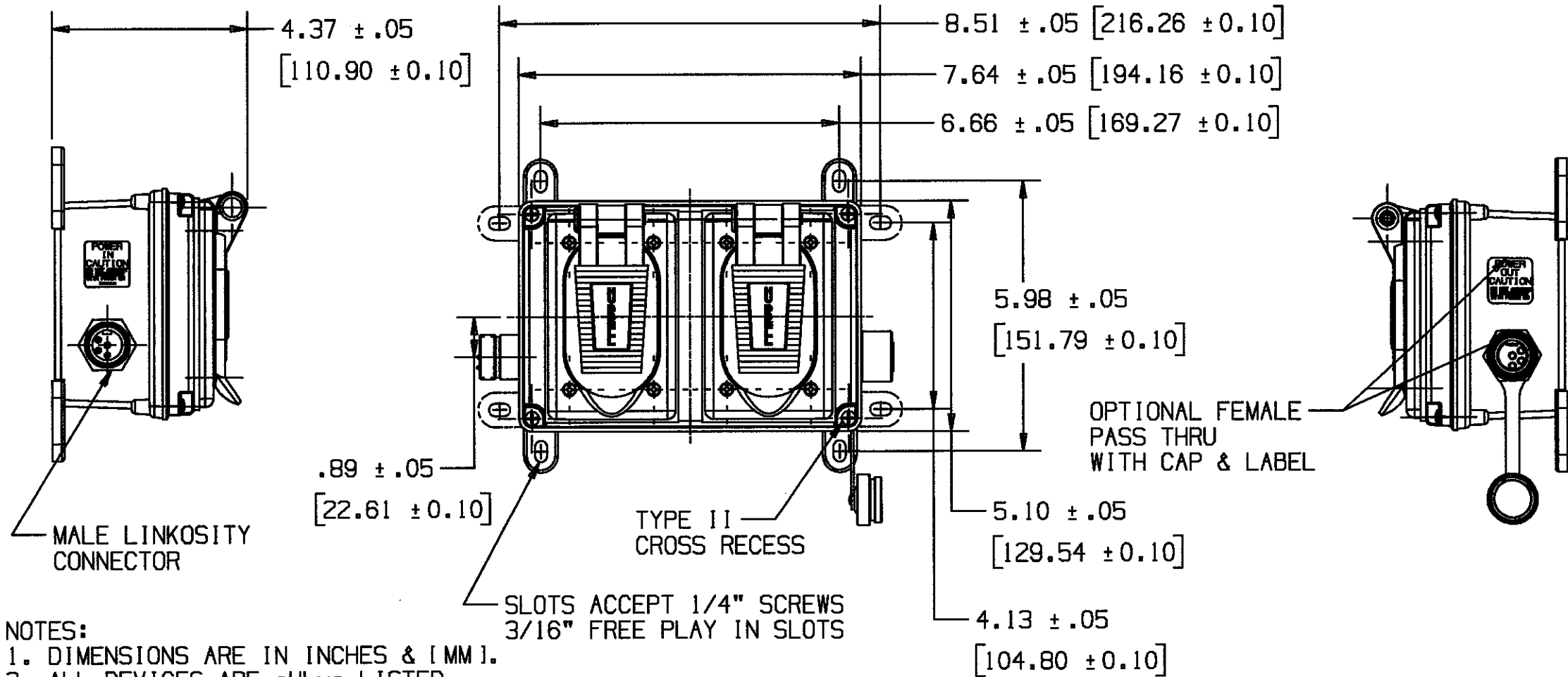

- NOTES:
1. DIMENSIONS ARE IN INCHES & [MM].
 2. ALL DEVICES ARE cULus LISTED.
 3. ENCLOSURE RATING: TYPE 3R.
 4. LINKOSITY™ IS A TRADEMARK OF LOCKHEED MARTIN.

STYLE ¹	
DIGIT	DESC.
3R	3R LID
3D	3R DEEP COVER

SWITCH TYPE ²	
DIGIT	DESC.
SL	LOCAL
SM	MASTER
00	NONE

RECEPTACLE TYPE ³	
DIGIT	DESC.
SG	SPEC. GRADE
HG	HOSPITAL GRADE
CR	CORR. RESIST.
L1	15A LOCKING
L2	20A LOCKING

RECEPTACLE FEATURE ⁴	
DIGIT	DESC.
IG	ISOLATED GRND.
GF	GRND. FAULT
SI	SURGE / IG
SS	SURGE
00	STD.

PASS THRU ⁵	
DIGIT	DESC.
P	PASS THRU
0	NO PASS THRU

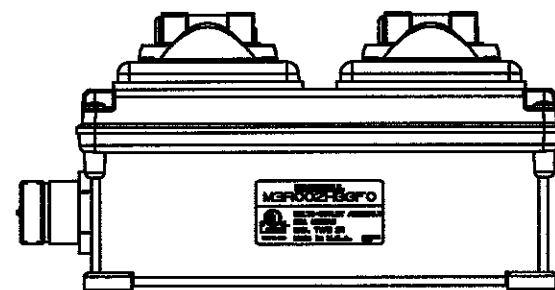

CATALOG NUMBER

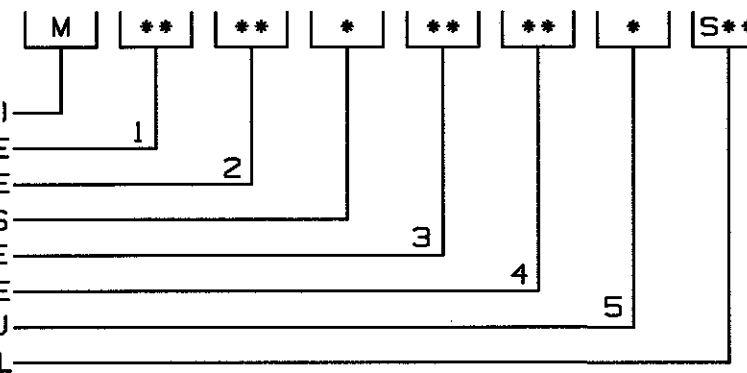

LIST OF PARTS		
DESCRIPTION	MATERIAL	FINISH
ALL EXTERNAL PLASTIC PARTS	UV STABILIZED POLYESTER/POLYCARBONATE BLEND	
ALL EXTERNAL SCREWS AND HARDWARE	STAINLESS STEEL	

1 RELEASED PER DCN#12718

WRV 11/9/05

SYM	REVISIONS	APP	DATE
		WRV	11/9/05

THE DESIGN AND DIMENSIONS OF THE PRODUCT SHOWN ON THIS DRAWING ARE SUBJECT TO CHANGE WITHOUT NOTICE

TITLE
LINKOSITY PSDA (DUPLX & GFCI VERSIONS)

TOLERANCES UNLESS OTHERWISE SPECIFIED	WIRING DEVICE-KELLEMS HUBBELL INCORPORATED BRIDGEPORT, CT	
FRACTIONS ± 1/64	DR. BY WRV	APP. BY TJS
DECIMALS ± .005	TR. BY	SCALE 1:3
ANGLES ± 2°	CHK'D BY	DATE 11/05

DIMENSION SHEET FOR CAT. NO. REPAIRABLE NON-REPAIRABLE B M-9959 1

M-10735 12

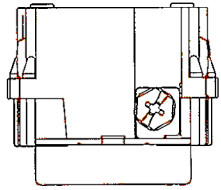

15AMP DEVICE

20AMP DEVICE

BLANK FACE DEVICE

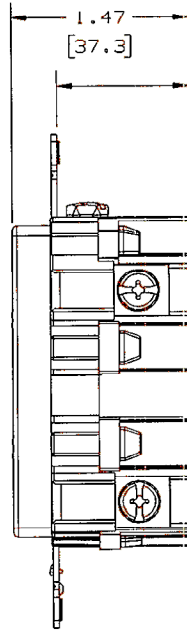

1.10
[27.8]

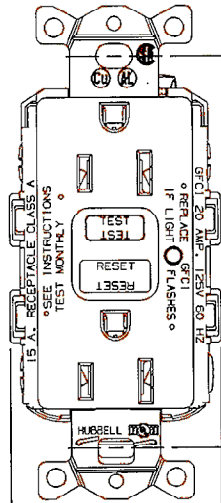

3.28
[83.8]

1.75
[44.5]

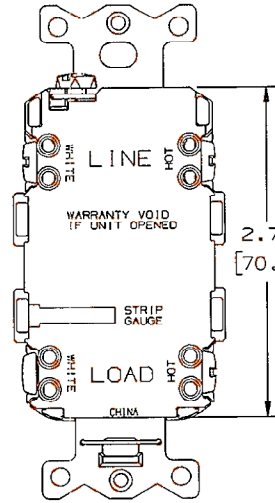
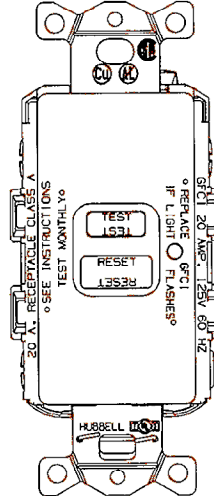
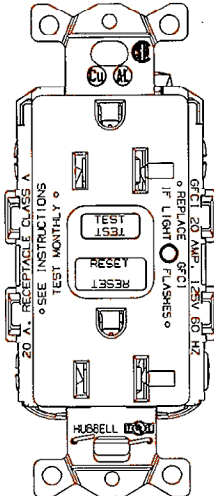

2.76
[70.0]

NOTE: RANDOM CONFIGURATIONS SHOWN.

COMMERCIAL UPGRADE, SPEC GRADE GFCI

BROWN	IVORY	WHITE	GRAY	BLACK	RED	OFFICE WHITE	ALMOND	LT. ALMOND	RATING
GF15LA	GF151LA	GF15WLA	GF15GYLA	GF15BKLA	GF15RLA	GF15OWLA	GF15ALLA	GF15LALA	15A, 125V
GF20LA	GF201LA	GF20WLA	GF20GYLA	GF20BKLA	GF20RLA	GF20OWLA	GF20ALLA	GF20LALA	20A, 125V
GFBF20LA	GFBF201LA	GFBF20WLA	GFBF20GYLA	GFBF20BKLA	GFBF20RLA	GFBF20OWLA	GFBF20ALLA	GFBF20LALA	20A, 125V
GF15LABULK	GF151LABULK	GF15WLABULK	GF15GYLABULK	GF15BKLABULK	GF15RLABULK	GF15OWLABULK	GF15ALLABULK	GF15LALABULK	15A, 125V
GF20LABULK	GF201LABULK	GF20WLABULK	GF20GYLABULK	GF20BKLABULK	GF20RLABULK	GF20OWLABULK	GF20ALLABULK	GF20LALABULK	20A, 125V
GFBF20LABULK	GFBF201LABULK	GFBF20WLABULK	GFBF20GYLABULK	GFBF20BKLABULK	GFBF20RLABULK	GFBF20OWLABULK	GFBF20ALABULK	GFBF20LALABULK	20A, 125V
WGF52LA	WGF521LA	WGF52WLA	-	WGF52BKLA	-	-	-	WGF52LALA	15A, 125V
WGF53LA	WGF531LA	WGF53WLA	-	GF20MBLT	-	-	-	WGF53LALA	20A, 125V
GF15LDEN	GF151LEA	GF15WLEA	-	-	-	-	-	-	15A, 125V
GF20LDEN	GF201LEA	GF20WLEA	-	-	-	-	-	-	20A, 125V
GFRS252W50L	GF151LAMP	GF15WLAMP	-	-	-	-	-	GF15LALAMP	15A, 125V

CODE 74545

LIST OF PARTS

DESCRIPTION	MATERIAL	FINISH
FACE	ZYTEL	
BRIDGE	STEEL	GALVANIZED
CONTACTS	BRASS	
CLAMP PLATES	BRASS	
BASE	ZYTEL	
MOUNTING SCREWS (NOT SHOWN)	STEEL	ZINC PLATE
BINDING SCREWS	STEEL	ZN & BRASS PLT W/ALUMINOTE

NO.	DESCRIPTION	APP.	DATE
12	ADDED CATALOG GF20MBLT TO TABLE. ADDED "NOTE: RANDOM CONFIGURATIONS SHOWN". PER DCN 19688 DDL	PJB	03/05/13
11	UPDATED VIEWS WITH REVISED LOCATION OF BRIDGE MARKINGS TO REFLECT CURRENT PRODUCTION. PER DCN 19213 DDL	PJB	12/07/12
10	ADDED TOP AND BOTTOM VIEWS TO DWG. PER DCN 19110 SPN	PJB	10/8/12
9	TITLE OF TABLE: COMMERCIAL UPGRADE SPEC GRADE GFCI WAS COMMERCIAL GRADE LED GFCI TITLE BLOCK: GFCI, COMMERCIAL UPGRADE SPEC GRADE WAS GFCI, INTERNAL BACKWIRE COMMERCIAL GRADE WITH LED PER DCN 18839	KP	2-9-12

SYM	REVISIONS	APP	DATE

THE DESIGN AND DIMENSIONS OF THE PRODUCT SHOWN ON THIS DRAWING ARE SUBJECT TO CHANGE WITHOUT NOTICE

TITLE
GFCI, COMMERCIAL UPGRADE SPEC GRADE

TOLERANCES UNLESS OTHERWISE SPECIFIED	WIRING DEVICE-KELLENS HUBBELL INCORPORATED SHELTON, CT	
.XX : ±.01	DR. BY	APP. BY
.XXX : ±.005	TR. BY	SCALE 1:1
ANGLES : ±2°	CHK. BY	DATE 8-2-07

DIMENSION SHEET FOR CAT. NO. SEE TABLE

REPAIRABLE

NON-REPAIRABLE

B

M-10735

12