

REV	DATE	DESCRIPTION	ECO	BY	CHK.
B	07/30/2014	DRAWING RELEASED	37118	RK	MB

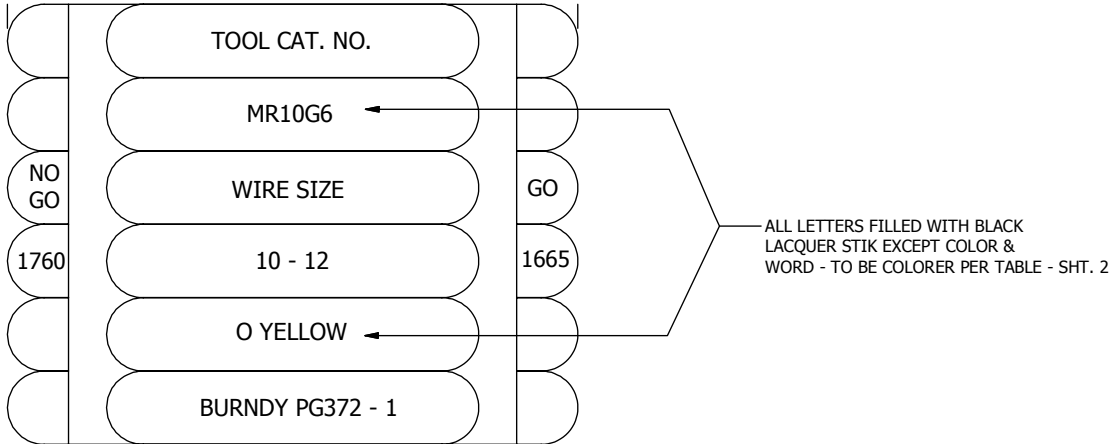
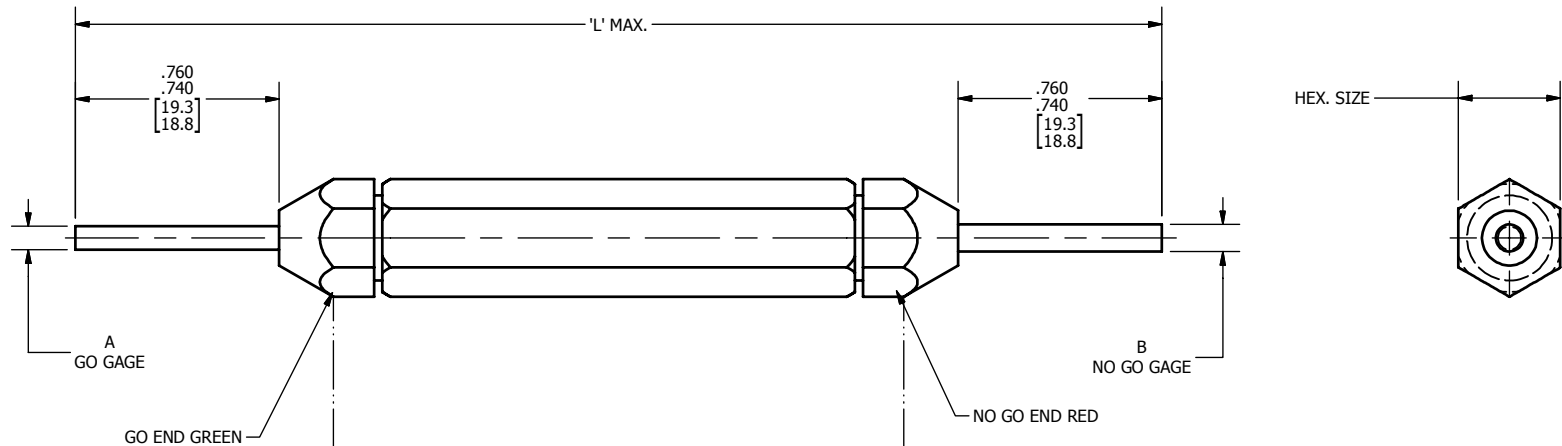

VIEW OF HEX HANDLE UNFOLDED
 TYP. LETTERING FOR HANDELS USED FOR NUCLEAR INDUSTRY APPLICATIONS.
 LETTERING TO APPEAR ON FLATS AND FILLED WITH LACQUER STIK - COLOR AS INDICATED
 (PG 372 - 1 ILLUSTRATED)

- NOTES:**
- DIMENSIONS IN BRACKETS [] ARE IN MILLIMETERS ROUNDED OFF TO THE NEAREST MILLIMETER, UNLESS OTHERWISE SPECIFIED AND ARE FOR REFERENCE ONLY.

TO ORDER BURNDY® PRODUCTS CALL		INSPECTION GAGE	
UNITED STATES 1-800-346-4175 (LONDONDERRY, NH)		ITEM NO: N/A	
CANADA: 1-800-361-6975 (QUEBEC) 1-800-387-6487 (ALL OTHER PROVINCES)		CAT. NO: PG (TABLE)	
FOR PRODUCT INFO: http://www.burndy.com		DRAWN BY: rkonathale 07/30/2014	
		CHECKER: --	
		DSN APRVL: P WASON 09/06/2014	
		MFG APRVL: W BENEICT 09/08/2014	
		QA APRVL: CLINDQUIST 09/08/2014	
		MKT APRVL: --	
		PROD FARM: --	
		PROJECT #: --	
		DOCUMENT TYPE: SALES	
		REL LEVEL: Released	
		DRAWING NO	
		WSC83822	
		SHEET 1 OF 50	
		REV	
		B	



CUSTOMER NAME	INDEX NO. USED BY CUSTOMER
CALLAWAY NUCLEAR FACILITY	PG230 - 1, 231 - 1, 232 - 1, 302 - 1, 314 - 1, 315 - 1, 316 - 1, 371 - 1, 372 - 1, 373 - 1.
WOLF CREEK NUCLEAR FACILITY	PG230 - 1, 231 - 1, 232 - 1, 302 - 1, 314 - 1, 315 - 1, 316 - 1, 371 - 1, 372 - 1, 373 - 1.
WASHINGTON PUBLIC POWER SYSTEMS 1 & 4	PG371 - 1, 372 - 1, 373 - 1
WASHINGTON PUBLIC POWER SYSTEMS HANFORD FACILITY	PG214 - 1
PHIPPS BEND NUCLEAR FACILITY	PG8 - 1, 202 - 1, 203 - 1, 302 - 1, 314 - 1, 371 - 1, 372 - 1, 373 - 1
TVA - BELEFONTE	PG208 - 1
TVA - HARTSVILE TENN	PG168 - 1, 169 - 1, 170 - 1, 171 - 1, 371 - 1, 372 - 1, 373 - 1
DUQUESNE P&L BARNER VALLEY UNIT 1	PG166 - 1, PG269 - 1, PG270 - 1, PG288 - 1

REV	DATE	DESCRIPTION	ECO	BY	CHK.
B	07/30/2014	DRAWING RELEASED	37118	RK	MB

NOTE :

THIS SHEET IS FOR BURNDY PERSONEL ONLY IT IS NOT TO BE ISSUED TO ANY CUSTOMER.

<p>TO ORDER BURNDY® PRODUCTS CALL</p> <p>UNITED STATES 1-800-346-4175 (LONDONDERRY, NH)</p> <p>CANADA: 1-800-361-6975 (QUEBEC) 1-800-387-6487 (ALL OTHER PROVINCES)</p> <p>FOR PRODUCT INFO: http://www.burndy.com</p>	CUSTOMER REFERENCE LIST			
	ITEM NO: N/A			
	CAT. NO: PG (TABLE)			
	DRAWN BY: rkonathale		07/30/2014	
	CHECKER: --			
	DSN APRVL: P WASON		09/06/2014	
	MFG APRVL: W BENEICT		09/08/2014	
	QA APRVL: C LINDQUIST		09/08/2014	
	MKT APRVL: --			
	PROD FIRM: --		DRAWING NO	
PROJECT #: --		W5C83822		
DOCUMENT TYPE: SALES		SIZE		
REL LEVEL: Released		B		
			REV	
			B	
			SHEET 2 OF 50	



GAGE CAT. NO.	'A'		'B'		DIE SET CAT NO.	GROOVE DESIGNATION	HEX SIZE	L' MAX
	GO GAGE		NO GO GAGE					
	SIZE	TOL.	SIZE	TOL.				
PG230-1	.0860 [2.184]	+0.002 -0.0000	.1000 [2.540]	+0.0000 -0.0002	MR8-33T-1	#18-32 RED	3/8	4.00 [101.6]
PG231-1	.1160 [2.946]	+0.0002 -0.0000	.1300 [3.302]	+0.0000 -0.0002	MR8-33T-1	#14-16 BLUE	3/8	4.00 [101.6]
PG232-1	.1440 [3.658]	+0.0002 -0.0000	.1580 [4.013]	+0.0000 -0.0002	MR8-33T-1	#10-12 YELLOW	3/8	4.00 [101.6]
PG302-1	.1570 [3.988]	+0.0002 -0.0000	.1670 [4.242]	+0.0000 -0.0002	MR8-83	#10-12 YELLOW	3/8	4.00 [101.6]
PG314-1	.1190 [3.023]	+0.0002 -0.0000	.1330 [3.378]	+0.0000 -0.0002	MR8-83	#14-22 RED/BLUE	3/8	4.00 [101.6]
PG315-1	.1310 [3.327]	+0.0002 -0.0000	.1410 [3.581]	+0.0000 -0.0002	MR8-83	#14-22 RED/BLUE	3/8	4.00 [101.6]
PG316-1	.1870 [4.750]	+0.0002 -0.0000	.2050 [5.207]	+0.0000 -0.0002	MR8-83	#10-12 YELLOW	9/16	4.75 [120.6]
PG371-1	.0965 [2.451]	+0.0002 -0.0000	.1060 [2.692]	+0.0000 -0.0002	MR1066	#14-16 BLUE	3/8	4.00 [101.6]
PG372-1	.1665 [4.229]	+0.0002 -0.0000	.1760 [4.470]	+0.0000 -0.0002	MR1066	#10-12 YELLOW	3/8	4.00 [101.6]
PG373-1	.0925 [2.350]	+0.0002 -0.0000	.1020 [2.591]	+0.0000 -0.0002	MR1066	#18-32 RED	3/8	4.00 [101.6]
PG214-1	.0429 [1.090]	+0.0002 -0.0000	.0495 [1.257]	+0.0000 -0.0002	S3D1	---	1/4	3.75 [95.3]
PG202-1	.0740 [1.880]	+0.0002 -0.0000	.0800 [2.032]	+0.0000 -0.0002	N14HET-25	#10-12 YELLOW	3/8	4.00 [101.6]
PG203-1	.0810 [2.057]	+0.0002 -0.0000	.0910 [2.311]	+0.0000 -0.0002	N14HET-25	#14-22 RED/BLUE	3/8	4.00 [101.6]
PG8-1	.0790 [2.007]	+0.0002 -0.0000	.0910 [2.311]	+0.0000 -0.0002	N10HT	#10 (NO COLOR)	3/8	4.00 [101.6]
PG208-1	.0700 [1.778]	+0.0002 -0.0000	.0760 [1.930]	+0.0000 -0.0002	Y20MRE-3	---	1/4	3.75 [95.3]
PG288-1	.0333 [0.846]	+0.0002 -0.0000	.0380 [0.965]	+0.0000 -0.0002	Y22MRH	---	1/4	3.75 [95.3]

REV	DATE	DESCRIPTION	ECO	BY	CHK.
B	07/30/2014	DRAWING RELEASED	37118	RK	MB

TO ORDER BURNDY® PRODUCTS CALL		INSPECTION GAGE	
UNITED STATES		ITEM NO: N/A	
1-800-346-4175 (LONDONDERRY, NH)		CAT. NO: PG (TABLE)	
CANADA:		DRAWN BY: rkonathale 07/30/2014	
1-800-361-6975 (QUEBEC)		CHECKER: --	
1-800-387-6487 (ALL OTHER PROVINCES)		DSN APRVL: P WASON 09/06/2014	
FOR PRODUCT INFO: http://www.burndy.com		MFG APRVL: W BENEDET 09/08/2014	
		QA APRVL: C LINDQUIST 09/08/2014	
		MKT APRVL: --	
		PROD FIRM: --	
		PROJECT #: --	
		DRAWING NO	
		WSC83822	
		REV	
		B	
		SHEET 3 OF 50	

REV	DATE	DESCRIPTION	ECO	BY	CHK.
B	07/30/2014	DRAWING RELEASED	37118	RK	MB

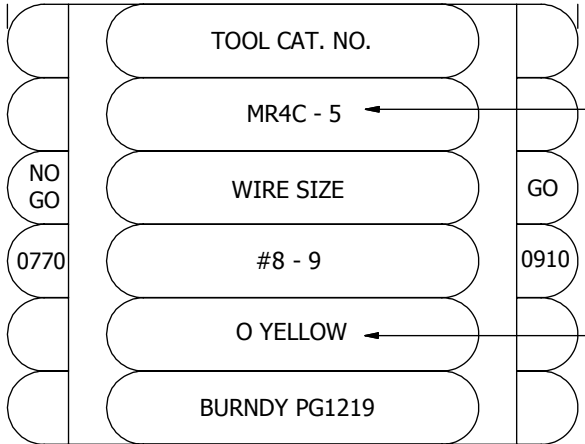
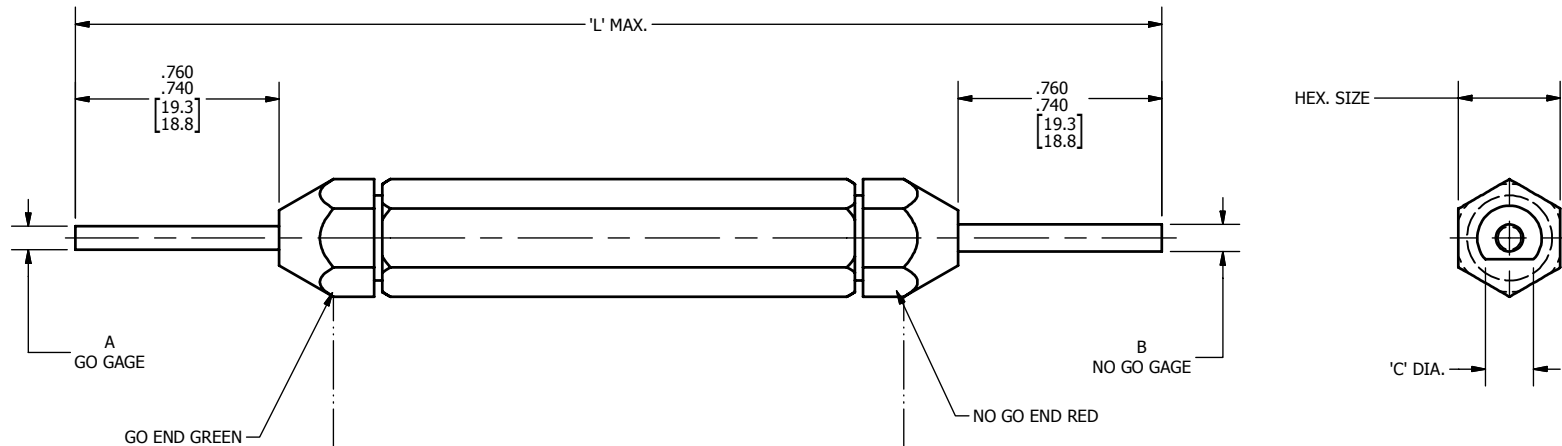

ALL LETTERS FILLED WITH BLACK LACQUER STIK EXCEPT COLOR & WORD - TO BE COLORER PER TABLE - SHT. 6

VIEW OF HEX HANDLE UNFOLDED
 TYP. LETTERING FOR HANDLES USED FOR NUCLEAR INDUSTRY APPLICATIONS.
 LETTERING TO APPEAR ON FLATS AND FILLED WITH LACQUER STIK - COLOR AS INDICATED
 (PG 372 - 1 ILLUSTRATED)

NOTES:

- DIMENSIONS IN BRACKETS [] ARE IN MILLIMETERS ROUNDED OFF TO THE NEAREST MILLIMETER, UNLESS OTHERWISE SPECIFIED AND ARE FOR REFERENCE ONLY.

TO ORDER BURNDY® PRODUCTS CALL		INSPECTION GAGE	
UNITED STATES 1-800-346-4175 (LONDONDERRY, NH)		ITEM NO: N/A	CAT. NO: PG (TABLE)
CANADA: 1-800-361-6975 (QUEBEC) 1-800-387-6487 (ALL OTHER PROVINCES)		DRAWN BY: rkonathale 07/30/2014	CHECKER: --
FOR PRODUCT INFO: http://www.burndy.com		DSN APRVL: P WASON 09/06/2014	MFG APRVL: W BENEICT 09/08/2014
		QA APRVL: CLINDQUIST 09/08/2014	MKT APRVL: --
		PROD FARM: --	PROJECT #: --
		DOCUMENT TYPE: SALES	REL LEVEL: Released
		DRAWING NO WSC83822	REV B
		SIZE B	SHEET 4 OF 50



CUSTOMER NAME	INDEX NO. USED BY CUSTOMER
CALLAWAY NUCLEAR FACILITY	PG121 - 1, 125 - 1, 133 - 1, 169 - 1, 170 - 1, 171 - 1
WOLF CREEK NUCLEAR FACILITY	PG121 - 1, 125 - 1, 133 - 1, 169 - 1, 170 - 1, 171 - 1
WASHINGTON PUBLIC POWER SUPPLY HANFORD FACILITY	PG121 - 1, 125 - 1, 133 - 1
PHIPPS BEND NUCLEAR FACILITY	PG160 - 1, 161 - 1, 168 - 1, 170 - 1, 171 - 1
CYBER NEX CO - MENTOR OH10	PG135 - 1, 136 - 1, 137 - 1

REV	DATE	DESCRIPTION	ECO	BY	CHK.
B	07/30/2014	DRAWING RELEASED	37118	RK	MB

NOTE :

THIS SHEET IS FOR BURNDY PERSONEL ONLY IT IS NOT TO BE ISSUED TO ANY CUSTOMER.

TO ORDER BURNDY® PRODUCTS CALL		CUSTOMER REFERENCE LIST	
UNITED STATES 1-800-346-4175 (LONDONDERRY, NH)		ITEM NO: N/A CAT. NO: PG____ (TABLE)	
CANADA: 1-800-361-6975 (QUEBEC) 1-800-387-6487 (ALL OTHER PROVINCES)		DRAWN BY: rkonathale 07/30/2014 CHECKER: -- DSN APRVL: P WASON 09/06/2014 MFG APRVL: W BENEDICT 09/08/2014 QA APRVL: C LINDQUIST 09/08/2014	
FOR PRODUCT INFO: http://www.burndy.com			
PROJ FIRM: -- PROJECT #: --		DRAWING NO WSC83822	
DOCUMENT TYPE: SALES REL LEVEL: Released		SIZE B	
		REV B	
		SHEET 5 OF 50	

BURNDY CAT. NO.	'A'		'B'		DIE SET CAT NO.	GROOVE DESIGNATION	HEX. SIZE	'L' MAX.	'C' DIA.	
	GO GAGE		NO GO GAGE						+ .000	- .005
	SIZE	TOL.	SIZE	TOL.						
PG121 - 1	.0770 [1.956]	+ .0005 - .0000	.0910 [2.311]	+ .0000 - .0005	MR4C - 5	#8 - 9	3/8	4.00 [101.6]	.120 [3.05]	
PG125 - 1	.0990 [2.515]	+ .0005 - .0000	.1130 [2.870]	+ .0000 - .0005	MR4C - 5	#6	3/8	4.00 [101.6]	.150 [3.81]	
PG133 - 1	.1550 [3.937]	+ .0005 - .0000	.1690 [4.293]	+ .0000 - .0005	MR4C - 5	#4	7/16	4.75 [120.6]	.210 [5.33]	
PG169 - 1	.0440 [1.118]	+ .0005 - .0000	.0610 [1.549]	+ .0000 - .0005	MR8698	#18 (NO COLOR)	1/4	3.75 [95.2]	.075 [1.91]	
PG170 - 1	.0540 [1.372]	+ .0005 - .0000	.0710 [1.803]	+ .0000 - .0005	MR8698	#14 (NO COLOR)	3/8	4.00 [101.6]	.090 [2.29]	
PG171 - 1	.0740 [1.880]	+ .0005 - .0000	.0910 [2.311]	+ .0000 - .0005	MR8698	#10 (NO COLOR)	3/8	4.00 [101.6]	.150 [3.81]	
PG160 - 1	.0450 [1.143]	+ .0005 - .0000	.0570 [1.448]	+ .0000 - .0005	N14HT	#18 (NO COLOR)	3/8	4.00 [101.6]	.100 [2.54]	
PG161 - 1	.0560 [1.422]	+ .0005 - .0000	.0680 [1.727]	+ .0000 - .0005	N14HT	#14 (NO COLOR)	3/8	4.00 [101.6]	.110 [2.79]	
PG168 - 1	.0250 [0.635]	+ .0005 - .0000	.0370 [0.940]	+ .0000 - .0005	MR8698	#22 (NO COLOR)	1/4	3.75 [95.2]	.050 [1.27]	
PG135 - 1	.1150 [2.921]	+ .0005 - .0000	.1250 [3.175]	+ .0000 - .0005	MR4 - 10M	#13 - 10 (NO COLOR)	3/8	4.00 [101.6]	.150 [3.81]	
PG136 - 1	.1410 [3.581]	+ .0005 - .0000	.1610 [4.089]	+ .0000 - .0005	MR4 - 10M	#8 (NO COLOR)	3/9	4.00 [101.6]	.180 [4.57]	
PG137 - 1	.1260 [3.200]	+ .0005 - .0000	.1480 [3.759]	+ .0000 - .0005	MR4 - 10M	#6 (NO COLOR)	3/8	4.00 [101.6]	.180 [4.57]	

REV	DATE	DESCRIPTION	ECO	BY	C'H'K.
B	07/30/2014	DRAWING RELEASED	37118	RK	MB

TO ORDER BURNDY® PRODUCTS CALL		INSPECTION GAGE	
UNITED STATES 1-800-346-4175 (LONDONDERRY, NH)		ITEM NO: N/A	
CANADA: 1-800-361-6975 (QUEBEC)		CAT. NO: PG (TABLE)	
1-800-387-6487 (ALL OTHER PROVINCES)		DRAWN BY: rkonathala 07/30/2014	
FOR PRODUCT INFO: http://www.burndy.com		CHECKER: --	
		DSN APRVL: P WASON 09/06/2014	
		MFG APRVL: W BENEDET 09/08/2014	
		QA APRVL: C LINDQUIST 09/08/2014	
		MKT APRVL: --	
		PROD FARM: --	
		PROJECT #: --	
		DRAWING NO	
		W5C83822	
		REV	
		B	
		SHEET 6 OF 50	

REV	DATE	DESCRIPTION	ECO	BY	CHK.
B	07/30/2014	DRAWING RELEASED	37118	RK	MB

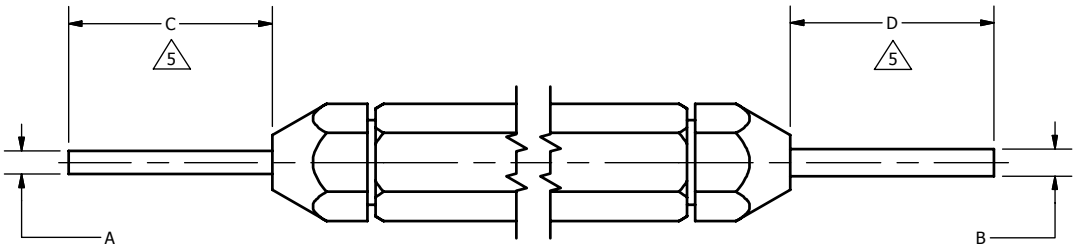

FIG. 1
(WIRE TYPE)

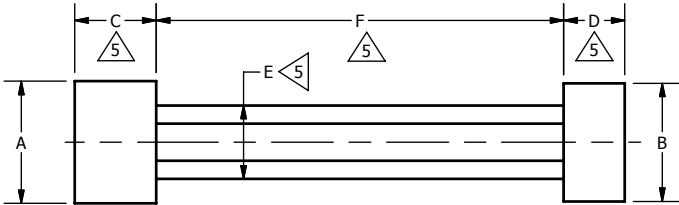
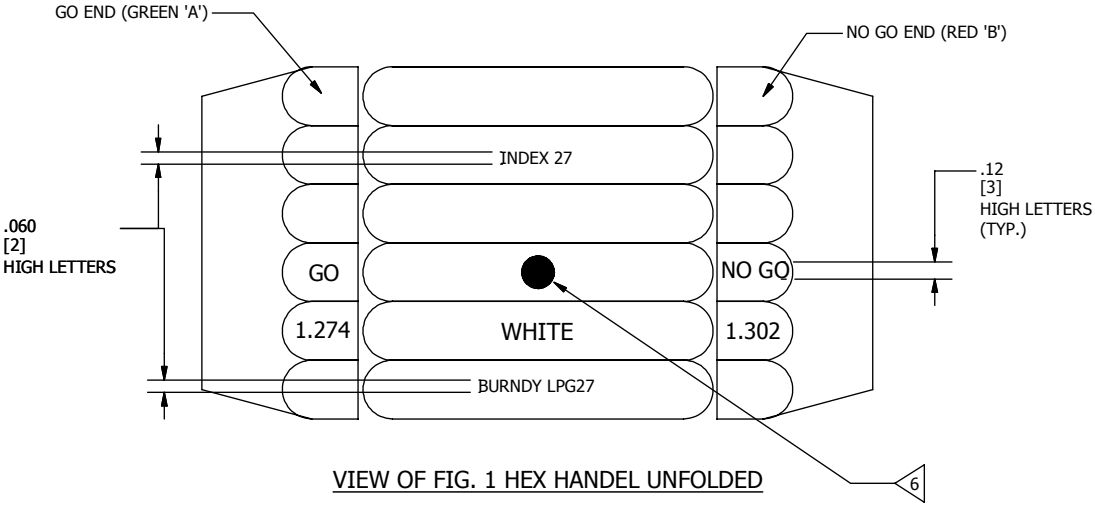
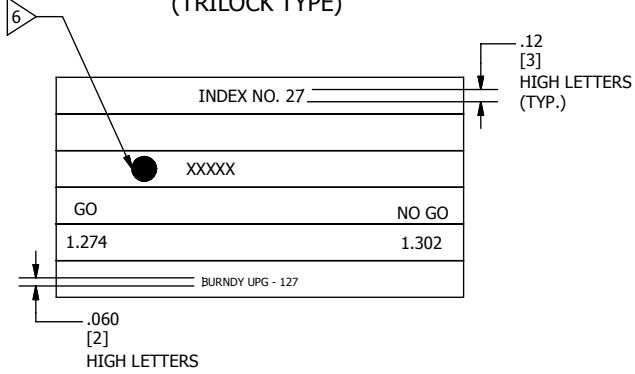

FIG. 2
(TRILOCK TYPE)



VIEW OF FIG. 1 HEX HANDEL UNFOLDED



VIEW OF FIG. 2 HEX HANDEL UNFOLDED

- NOTES :
- TOLERANCE FOR FIG TYPES ARE AS FOLLOES:
 FIG.1 = +.0002 & -.0002
 FIG.2 = +.0003 & -.0003
 FIG.3 = +.0003 & -.0003
 FIG.4 = +.0005 & -.0005

- ALL LETTERING PER BURNDY SPEC. L217 GROUP 1B. LETTERING TO BE FILLED WITH BLACK LACQUER.
- DIMS. C-D-E-F ARE GAGE MFG'S STANDARD, UNLESS OTHERWISE SPECIFIED.
- .12 DIA. SPOT DRILL COLOR DOT & WORD TO BE FILLED WITH PAINT STIK IN APPROPRIATE COLOR (SEE TABLE)

TO ORDER BURNDY® PRODUCTS CALL		INSPECTION GAGE	
UNITED STATES 1-800-346-4175 (LONDONDERRY, NH)		ITEM NO: N/A	
CANADA: 1-800-361-6975 (QUEBEC) 1-800-387-6487 (ALL OTHER PROVINCES)		CAT. NO: LPG (TABLE)	
FOR PRODUCT INFO: http://www.burndy.com		DRAWN BY: rkonathala 07/30/2014	
		CHECKER: --	
		DSN APRVL: P WASON 09/06/2014	
		MFG APRVL: W BENEICT 09/08/2014	
		QA APRVL: C LINDQUIST 09/08/2014	
		MKT APRVL: --	
		PROD FAM: --	
		PROJECT #: --	
		DOCUMENT TYPE: SALES	
		REL LEVEL: Released	
		DRAWING NO	
		WSC83822	
		SHEET 7 OF 50	
		REV	
		B	

CUSTOMER NAME	INDEX NO. USED BY CUSTOMER
CALLAWAY NUCLEAR FACILITY	LPG27, 34
WOLF CREEK NUCLEAR FACILITY	LPG27, 34
PHIPPS BEND NUCLEAR FACILITY	LPG 722, 728, 790
BECHTEL CORP - LIMERICK PLANT	LPG 33, 479
TOLEDO EDISON NUCLEAR PLANT	LPG 17, 18, 19, 20, 22, 24, 27, 31, 34

REV	DATE	DESCRIPTION	ECO	BY	CHK.
B	07/30/2014	DRAWING RELEASED	37118	RK	MB

NOTE :

THIS SHEET IS FOR BURNDY PERSONEL ONLY. IT IS NOT TO BE ISSUED TO ANY CUSTOMER.

TO ORDER BURNDY® PRODUCTS CALL		CUSTOMER REFERENCE LIST	
UNITED STATES 1-800-346-4175 (LONDONDERRY, NH)		ITEM NO: N/A CAT. NO: LPG (TABLE)	
CANADA: 1-800-361-6975 (QUEBEC) 1-800-387-6487 (ALL OTHER PROVINCES)		DRAWN BY: rkonathala 07/30/2014 CHECKER: -- DSN APRVL: P WASON 09/06/2014 MFG APRVL: W BENEDICT 09/08/2014 QA APRVL: C LINDQUIST 09/08/2014 MKT APRVL: --	
FOR PRODUCT INFO: http://www.burndy.com			
PROJ FIRM: -- PROJECT #: --		DRAWING NO WSC83822	
DOCUMENT TYPE: SALES REL LEVEL: Released		SIZE B	
		SHEET 8 OF 50	
		REV B	

REV	DATE	DESCRIPTION	ECO	BY	CHK.
B	07/30/2014	DRAWING RELEASED	37118	RK	MB

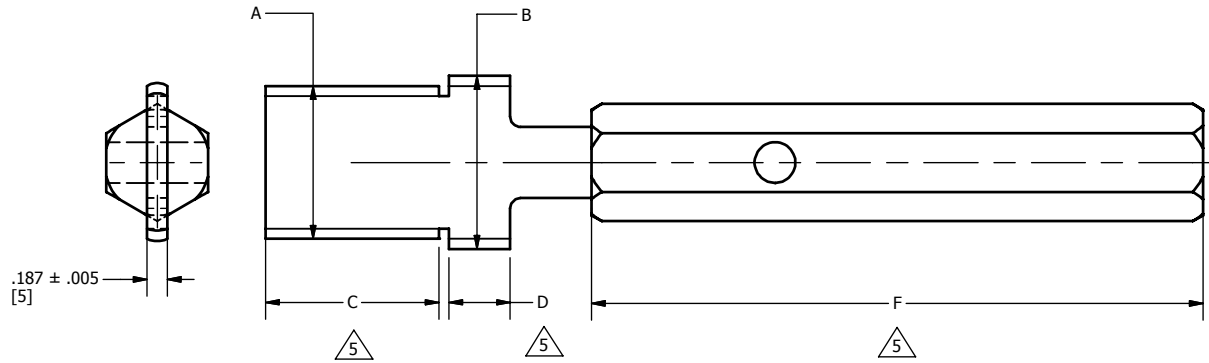

FIG. 3

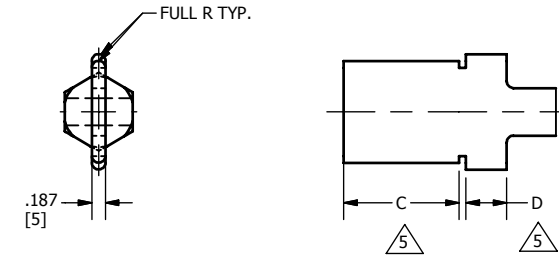
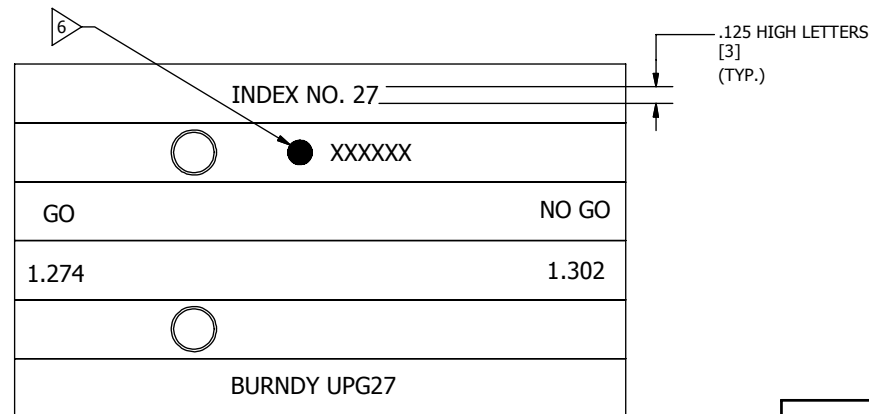

FIG. 4

(USE SAME HANDLE AS FIG. 3)



VIEW OF FIG. 3 HEX HANDLE UNFOLDED

NOTES:

- DIMENSIONS IN BRACKETS [] ARE IN MILLIMETERS ROUNDED OFF TO THE NEAREST MILLIMETER, UNLESS OTHERWISE SPECIFIED AND ARE FOR REFERENCE ONLY.

6 .12 DIA. SPOT DRILL, COLOR DOT & WORD TO BE FILLED WITH PAINT STIK IN APPROPRIATE COLOR (SEE TABLE)

TO ORDER BURNDY® PRODUCTS CALL		INSPECTION GAGE	
UNITED STATES 1-800-346-4175 (LONDONDERRY, NH)		ITEM NO: N/A	CAT. NO: LPG (TABLE)
CANADA: 1-800-361-6975 (QUEBEC) 1-800-387-6487 (ALL OTHER PROVINCES)		DRAWN BY: rkonathale 07/30/2014	CHECKER: --
FOR PRODUCT INFO: http://www.burndy.com		DSN APRVL: P WASON 09/06/2014	MFG APRVL: W BENEDET 09/08/2014
		QA APRVL: C LINDQUIST 09/08/2014	MKT APRVL: --
		PROJ FIRM: --	PROJECT #: --
		DOCUMENT TYPE: SALES	REL LEVEL: Released
		DRAWING NO WSC83822	REV B
		SHEET 9 OF 50	

BURNDY CATALOG NO.	FIG. NO.	'A'		'B'		DIE SET CATALOG NO.	DIE SET 'G' DIM.	COLOR DOT PER MUNSELL COLOR CHART
		GO GAGE		NO GO GAGE				
		SIZE	TOL.	SIZE	TOL.			
LPG -5	---	---	---	---	---	---	---	---
LPG -10	---	---	---	---	---	---	---	---
LPG -15	---	---	---	---	---	---	---	---
LPG -17	4	.6760 [17.170]	+0.004 -0.000	.7040 [17.170]	+0.000 -0.004	L30RT	.696 [17.68] .704 [17.88]	NO REQ.
LPG -18	1	.7260 [18.440]	+0.002 -0.000	.7540 [18.440]	+0.000 -0.002	L31RT	.746 [18.95] .754 [19.15]	NO REQ.
LPG -19	4	.7880 [20.015]	+0.004 -0.000	.8160 [20.015]	+0.000 -0.004	L32RT	.808 [20.52] .816 [20.73]	NO REQ.
LPG -20	2	.8920 [22.657]	+0.003 -0.000	.9200 [22.657]	+0.000 -0.003	L34RT	.912 [23.16] .920 [23.37]	NO REQ.
LPG -22	4	.9800 [24.892]	+0.004 -0.000	1.0080 [24.892]	+0.000 -0.004	L36RT	1.000 [25.40] 1.008 [28.09]	NO REQ.
LPG -24	4	1.0860 [27.584]	+0.004 -0.000	1.1140 [27.584]	+0.000 -0.004	L39RT	1.106 [28.09] 1.114 [28.30]	NO REQ.
LPG -26	---	---	---	---	---	---	---	---

REV	DATE	DESCRIPTION	ECO	BY	CHK.
B	07/30/2014	DRAWING RELEASED	37118	RK	MB

TO ORDER BURNDY® PRODUCTS CALL		INSPECTION GAGE	
UNITED STATES		ITEM NO: N/A	
1-800-346-4175 (LONDONDERRY, NH)		CAT. NO: LPG (TABLE)	
CANADA:		DRAWN BY: rkonathala 07/30/2014	
1-800-361-6975 (QUEBEC)		CHECKER: --	
1-800-387-6487 (ALL OTHER PROVINCES)		DSN APRVL: P WASON 09/06/2014	
FOR PRODUCT INFO: http://www.burndy.com		MFG APRVL: W BENEDET 09/08/2014	
		QA APRVL: C LINDQUIST 09/08/2014	
		MKT APRVL: --	
		PROD FIRM: --	
		PROJECT #: --	
		DRAWING NO	
		WSC83822	
		SHEET 10 OF 50	
		REV	
		B	

GAGE CAT. NO.	FIG. NO.	'A'		'B'		DIE SET CAT NO.	DIE SET 'G' DIM.	COLOR DOT PER MUNSSELL COLOR CHART
		GO GAGE		NO GO GAGE				
		SIZE	TOL.	SIZE	TOL.			
LPG - 27	3	1.2740 [32.36]	+0.0003 -0.0000	1.3020 [33.07]	+0.0000 -0.0003	L44RT	1.294 [32.87] 1.302 [33.07]	WHITE #9.5
LPG - 28	---	---	---	---	---	---	---	---
LPG - 29	---	---	---	---	---	---	---	---
LPG - 30	---	---	---	---	---	---	---	---
LPG - 31	4	1.5700 [39.88]	+0.0003 -0.0000	1.5980 [40.59]	+0.0000 -0.0003	L46RT	1.590 [40.39] 1.598 [40.59]	GREEN 56Y 3/4 - 10GY 3/2
LPG - 32	---	---	---	---	---	---	---	---
LPG - 33	3	1.6340 [41.50]	+0.0003 -0.0000	1.6620 [42.21]	+0.0000 -0.0003	L47RT	1.654 [42.01] 1.662 [42.21]	GRAY 6.0/0 - NS .010
LPG - 34	3	1.8160 [46.13]	+0.0003 -0.0000	1.8440 [46.84]	+0.0000 -0.0003	L48RT	1.836 [46.63] 1.844 [46.84]	BROWN 5YR 4/10 - 5YR 3/16
LPG - 50	---	---	---	---	---	---	---	---

REV	DATE	DESCRIPTION	ECO	BY	CHK.
B	07/30/2014	DRAWING RELEASED	37118	RK	MB

TO ORDER BURNDY® PRODUCTS CALL		INSPECTION GAGE	
UNITED STATES		ITEM NO: N/A	
1-800-346-4175 (LONDONDERRY, NH)		CAT. NO: LPG (TABLE)	
CANADA:		DRAWN BY: rkonathala 07/30/2014	
1-800-361-6975 (QUEBEC)		CHECKER: --	
1-800-387-6487 (ALL OTHER PROVINCES)		DSN APRVL: P WASON 09/06/2014	
FOR PRODUCT INFO: http://www.burndy.com		MFG APRVL: W BENEDET 09/08/2014	
		QA APRVL: C LINDQUIST 09/08/2014	
		MKT APRVL: --	
		PROD FIRM: --	
		PROJECT #: --	
		DRAWING NO	
		WSC83822	
		SHEET 11 OF 50	
		REV	
		B	

CATALOG NO.	FIG. NO.	'A'		'B'		DIE SET CAT NO.	DIE SET 'G' DIM.	COLOR DOT PER MUNSSELL COLOR CHART
		GO GAGE		NO GO GAGE				
		SIZE	TOL.	SIZE	TOL.			
LPG459	---	---	---	---	---	---	---	---
LPG299	4	.8940 [22.708]	+ .0003 - .0000	.9220 [23.419]	+ .0000 - .0003	L31ART	.914 [23.22] .922 [23.42]	---
LPG301	4	1.3160 [33.426]	+ .0003 - .0000	1.3440 [34.138]	+ .0000 - .0003	L39ART	1.336 [33.93] 1.344 [34.14]	---
LPG478	4	1.9760 [50.190]	+ .0003 - .0000	2.0040 [50.902]	+ .0000 - .0003	L46ART	1.996 [50.70] 2.004 [50.90]	---
LPG479	2	2.1660 [55.016]	+ .0004 - .0000	2.2340 [56.744]	+ .0000 - .0004	L48ART	2.186 [55.52] 2.234 [56.74]	RED 7.5 MAX. 7.5R 4/12
LPG482	---	---	---	---	---	---	---	---

REV	DATE	DESCRIPTION	ECO	BY	C'HK.
B	07/30/2014	DRAWING RELEASED	37118	RK	MB

TO ORDER BURNDY® PRODUCTS CALL		INSPECTION GAGE	
UNITED STATES		ITEM NO: N/A	
1-800-346-4175 (LONDONDERRY, NH)		CAT. NO: LPG (TABLE)	
CANADA:		DRAWN BY: rkonathala 07/30/2014	
1-800-361-6975 (QUEBEC)		CHECKER: --	
1-800-387-6487 (ALL OTHER PROVINCES)		DSN APRVL: P WASON 09/06/2014	
FOR PRODUCT INFO: http://www.burndy.com		MFG APRVL: W BENEDET 09/08/2014	
		QA APRVL: C LINDQUIST 09/08/2014	
		MKT APRVL: --	
		PROD FARM: --	
		PROJECT #: --	
		DRAWING NO	
		WSC83822	
		REV	
		B	
		SHEET 12 OF 50	

GAGE CAT. NO.	FIG. NO.	'A'		'B'		DIE SET CAT NO.	DIE SET 'G' DIM.	COLOR DOT PER MUNSSELL COLOR CHART
		GO GAGE		NO GO GAGE				
		SIZE	TOL.	SIZE	TOL.			
LPG715	---	---	---	---	---	---	---	---
LPG722	3	1.2260 [31.140]	+0.0003 -0.0000	1.2540 [31.852]	+0.0000 -0.0003	L722	1.246 [31.65] 1.254 [31.65]	NO REQ.
LPG728	3	1.8660 [47.396]	+0.0003 -0.0000	1.3940 [35.408]	+0.0000 -0.0003	L728	1.886 [47.90] 1.894 [48.11]	NO REQ.
LPG733	---	---	---	---	---	---	---	---

REV	DATE	DESCRIPTION	ECO	BY	CHK.
B	07/30/2014	DRAWING RELEASED	37118	RK	MB

TO ORDER BURNDY® PRODUCTS CALL		INSPECTION GAGE	
UNITED STATES		ITEM NO: N/A	
1-800-346-4175 (LONDONDERRY, NH)		CAT. NO: LPG (TABLE)	
CANADA:		DRAWN BY: rkonathala 07/30/2014	
1-800-361-6975 (QUEBEC)		CHECKER: --	
1-800-387-6487 (ALL OTHER PROVINCES)		DSN APRVL: P WASON 09/06/2014	
FOR PRODUCT INFO: http://www.burndy.com		MFG APRVL: W BENEDICT 09/08/2014	
		QA APRVL: C LINDQUIST 09/08/2014	
		MKT APRVL: --	
		PROD FIRM: --	
		PROJECT #: --	
		DRAWING NO	
		SIZE	
		WSC83822	
		B	
		SHEET 13 OF 50	
		REV	
		B	

GAGE CAT. NO.	FIG. NO.	'A'		'B'		DIE SET CAT NO.	DIE SET 'G' DIM.	COLOR DOT PER MUNSELL COLOR CHART
		GO GAGE		NO GO GAGE				
		SIZE	TOL.	SIZE	TOL.			
LPG739	---	---	---	---	---	---	---	---
LPG740	3	2.1760 [31.140]	+0.0003 -0.0000	2.2040 [47.396]	+0.0000 -0.0003	L740	2.196 [31.85] 2.204 [35.41]	NO REQ.
LPG762	---	---	---	---	---	---	---	---

REV	DATE	DESCRIPTION	ECO	BY	CHK.
B	07/30/2014	DRAWING RELEASED	37118	RK	MB

TO ORDER BURNDY® PRODUCTS CALL		INSPECTION GAGE	
UNITED STATES		ITEM NO: N/A	
1-800-346-4175 (LONDONDERRY, NH)		CAT. NO: LPG___ (TABLE)	
CANADA:		DRAWN BY: rkonathale 07/30/2014	
1-800-361-6975 (QUEBEC)		CHECKER: --	
1-800-387-6487 (ALL OTHER PROVINCES)		DSN APRVL: P WASON 09/06/2014	
FOR PRODUCT INFO: http://www.burndy.com		MFG APRVL: W BENEDICT 09/08/2014	
		QA APRVL: C LINDQUIST 09/08/2014	
		MKT APRVL: --	
		PROJ. #:	
		SIZE	
		DRAWING NO	
		WSC83822	
		REV	
		B	
		SHEET 14 OF 50	



REV	DATE	DESCRIPTION	ECO	BY	CHK.
B	07/30/2014	DRAWING RELEASED	37118	RK	MB

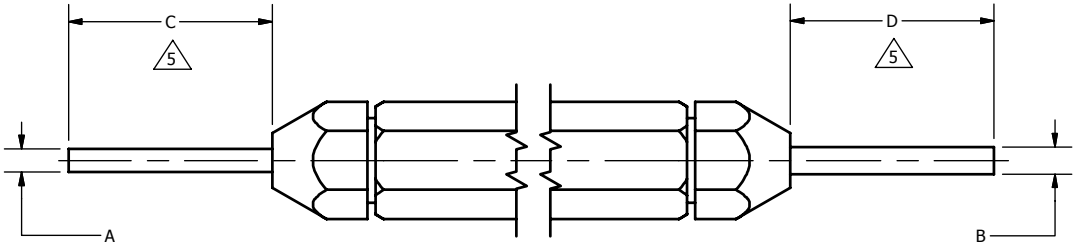

FIG. 1
(WIRE TYPE)

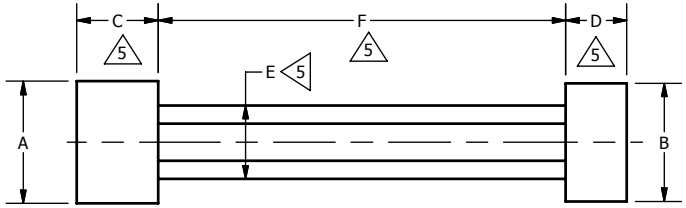
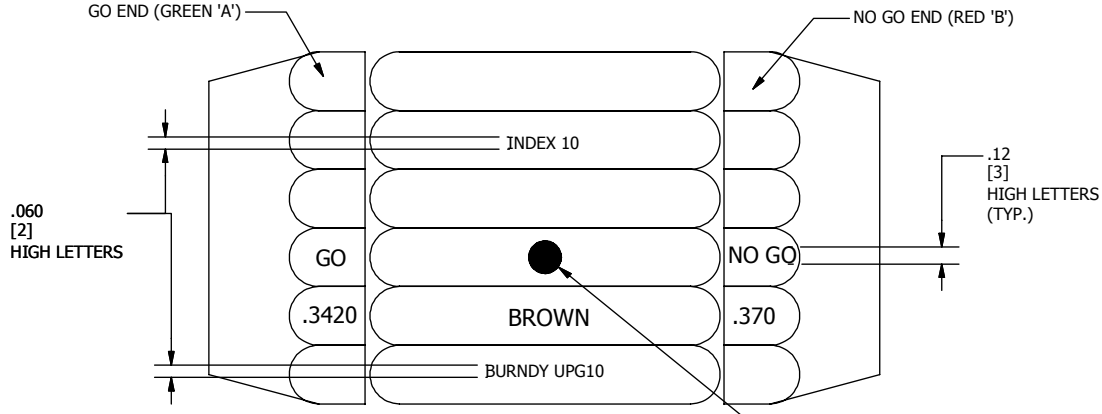
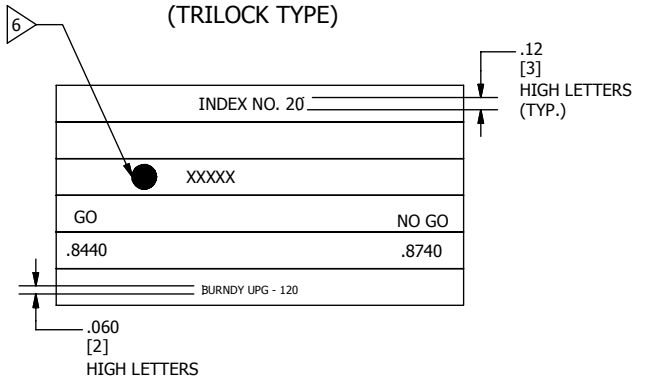

FIG. 2
(TRILOCK TYPE)



VIEW OF FIG. 1 HEX HANDEL UNFOLDED



VIEW OF FIG. 2 HEX HANDEL UNFOLDED

NOTES :

1 TOLERANCE FOR FIG TYPES ARE AS FOLLOES:
 FIG.1 = +.0002 & -.0002
 FIG.2 = +.0003 & -.0003
 FIG.3 = +.0003 & -.0003
 FIG.4 = +.0005 & -.0005

4. ALL LETTERING PER BURNDY SPEC. L217 GROUP 1B. LETTERING TO BE FILLED WITH BLACK LACQUER.

5 DIMS. C-D-E-F ARE GAGE MFG'S STANDARD, UNLESS OTHERWISE SPECIFIED.

6 .12 DIA. SPOT DRILL COLOR DOT & WORD TO BE FILLED WITH PAINT STIK IN APPROPRIATE COLOR (SEE TABLE)

TO ORDER BURNDY® PRODUCTS CALL		INSPECTION GAGE	
UNITED STATES 1-800-346-4175 (LONDONDERRY, NH)		ITEM NO: N/A	
CANADA: 1-800-361-6975 (QUEBEC) 1-800-387-6487 (ALL OTHER PROVINCES)		CAT. NO: UPG (TABLE)	
FOR PRODUCT INFO: http://www.burndy.com		DRAWN BY: rkonathale 07/30/2014	
		CHECKER: --	
		DSN APRVL: P WASON 09/06/2014	
		MFG APRVL: W BENEICT 09/08/2014	
		QA APRVL: C LINDQUIST 09/08/2014	
		MKT APRVL: --	
		PROD FAM: --	
		PROJECT #: --	
		DOCUMENT TYPE: SALES	
		REL LEVEL: Released	
		DRAWING NO	
		WSC83822	
		SHEET 15 OF 50	
		REV	
		B	

CUSTOMER NAME	INDEX NO. USED BY CUSTOMER
CALLAWAY NUCLEAR FACILITY	UPG7, 8, 9, 10, 11-B, 12, 13, 14, 15, 16, 17, 18, 19, 20, 22, 24, 49
WOLF CREEK NUCLEAR FACILITY	UPG7, 8, 9, 10, 11-B, 12, 13, 14, 15, 16, 17, 18, 19, 20, 22, 24, 49
WASHINGTON PUBLIC POWER SYSTEM 1&4	UPG7, 8, 10, 13, 15, 16, 18, 20, UPG - C, UPG - 0, 1, UPG - 997, UPG348, 375
SOUTH TEXAS NUCLEAR FACILITY	UPG7, 8, 10, 12, 13, 15, 16, 18, 20, 24, 49
PHIPPS BEND NUCLEAR FACILITY	UPG7, 8, 10, 12, 13, 15, 16, 17, 19, 20, 49 UPG - C
COMMANCHE PEAK STATION	UOG300, UPG473
TVA - HAPTSVILLE TENN	UPG7, 8, 10, 12, 13, 15, 16, 17, 18, 19, 20, 49, 163, 209
MERCURY CO-MILLSTONE NUC. SITE	UPG8, 10, 13, 15, 16, 18, 49
BECHTEL POWER CORP - SANATOGA	UPG7, 8, 10, 11-B, 12, 13, 15, 16, 18, 20, 24, 49
SEABROOK - SUB - STA, SEABROOK N.H.	UPG170, UPG163, 165, 168, 209
FAIR BANKS MORSE CO BELOIT, WISCONSIN	UPG340, 353, 355, 356

REV	DATE	DESCRIPTION	ECO	BY	CHK.
B	07/30/2014	DRAWING RELEASED	37118	RK	MB

NOTES :

- THIS SHEET IS FOR BUNDY PERSONEL ONLY IT IS NOT TO BE ISSUED TO ANY CUSTOMER.
- CAT. NO. UPG11 SUPERSEDED BY UPG11-B.

TO ORDER BURNDY® PRODUCTS CALL		CUSTOMER REFERENCE LIST	
UNITED STATES 1-800-346-4175 (LONDONDERRY, NH)		ITEM NO: N/A	
CANADA: 1-800-361-6975 (QUEBEC) 1-800-387-6487 (ALL OTHER PROVINCES)		CAT. NO: UPG (TABLE)	
FOR PRODUCT INFO: http://www.burndy.com		DRAWN BY: rkonathale 07/30/2014	
		CHECKER: --	
		DSN APRVL: P WASON 09/06/2014	
		MFG APRVL: W BENEDICT 09/08/2014	
		QA APRVL: CLINDQUIST 09/08/2014	
		MKT APRVL: --	
		PROD FARM: --	
		PROJECT #: --	
		DRAWING NO	
		SIZE	
		WSC83822	
		B	
		SHEET 16 OF 50	
		REV	
		B	



REV	DATE	DESCRIPTION	ECO	BY	CHK.
B	07/30/2014	DRAWING RELEASED	37118	RK	MB

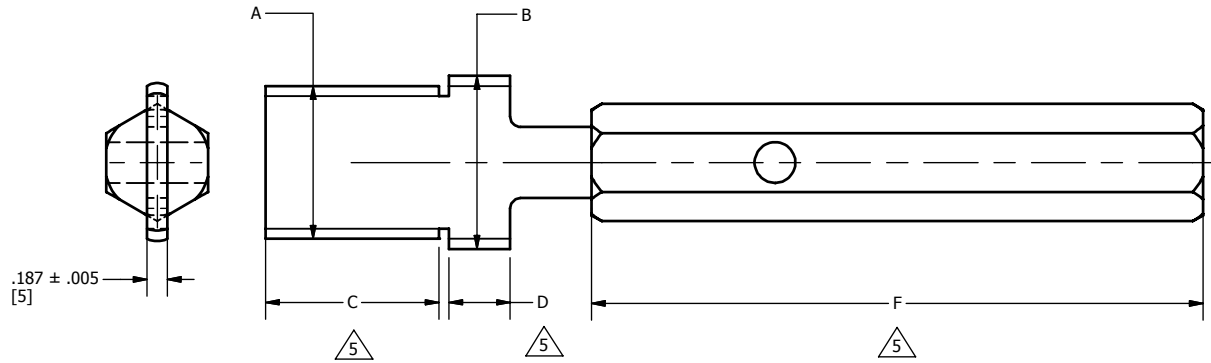

FIG. 3

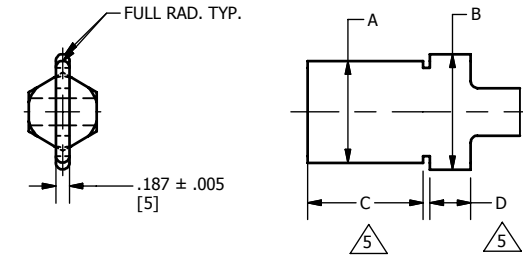
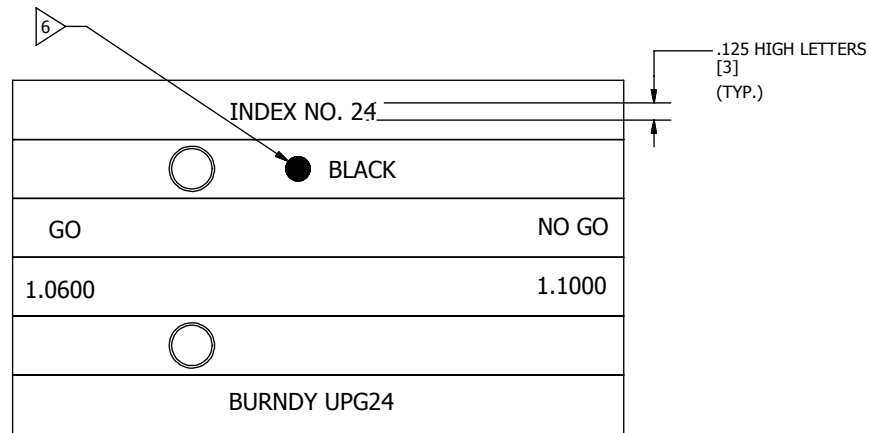

FIG. 4 & 4A
(USE SAME HANDLE AS FIG. 3)



NOTES:

1. DIMENSIONS IN BRACKETS [] ARE IN MILLIMETERS ROUNDED OFF TO THE NEAREST MILLIMETER, UNLESS OTHERWISE SPECIFIED AND ARE FOR REFERENCE ONLY.

6 .12 DIA. SPOT DRILL, COLOR DOT & WORD TO BE FILLED WITH PAINT STIK IN APPROPRIATE COLOR (SEE TABLE)

7 FIG. 4A IS SAME AS FIG. 4 EXCEPT BLADE THICKNESS IS .125 ± .005

VIEW OF HEX HANDLE UNFOLDED
(TYP. FOR FIG 3 & 4)

TO ORDER BURNDY® PRODUCTS CALL		INSPECTION GAGE	
UNITED STATES 1-800-346-4175 (LONDONDERRY, NH)		ITEM NO: N/A	CAT. NO: UPG (TABLE)
CANADA: 1-800-361-6975 (QUEBEC) 1-800-387-6487 (ALL OTHER PROVINCES)		DRAWN BY: rkonathale 07/30/2014	CHECKER: --
FOR PRODUCT INFO: http://www.burndy.com		DSN APRVL: P WASON 09/06/2014	MFG APRVL: W BENEICT 09/08/2014
		QA APRVL: C LINDQUIST 09/08/2014	MKT APRVL: --
		PROD FARM: --	PROJECT #: --
		DOCUMENT TYPE: SALES	REL LEVEL: Released
		SIZE: B	DRAWING NO: WSC83822
			REV: B
			SHEET 17 OF 50

GAGE CAT. NO.	FIG. NO.	'A'		'B'		DIE SET CAT NO.	DIE SET 'G' DIM.	COLOR DOT PER MUNSELL COLOR CHART
		GO GAGE		NO GO GAGE				
		SIZE	TOL. \triangleleft	SIZE	TOL. \triangleleft			
UPG - A	---	---	---	---	---	---	---	---
UPG - B	---	---	---	---	---	---	---	---
UPG - C	4	.6940 [17.628]	+0.0005 -.0000	.7240 [18.390]	+0.0000 -.0005	U - C	.714 [18.14] .724 [18.39]	NO REQT.
UPG - D	---	---	---	---	---	---	---	---
UPG - E	---	---	---	---	---	---	---	---
UPG - F	---	---	---	---	---	---	---	---
UPG - G	---	---	---	---	---	---	---	---
UPG - H	---	---	---	---	---	---	---	---
UPG - K	---	---	---	---	---	---	---	---
UPG - L	---	---	---	---	---	---	---	---
UPG - M	---	---	---	---	---	---	---	---
UPG - N	---	---	---	---	---	---	---	---
UPG - O	4	.8120 [20.625]	+0.0005 -.0000	.8420 [21.387]	+0.0000 -.0005	U - O	.832 [21.13] .842 [21.39]	NO REQT.
UPG - Q	---	---	---	---	---	---	---	---
UPG - R	---	---	---	---	---	---	---	---
UPG - S	---	---	---	---	---	---	---	---
UPG - T	---	---	---	---	---	---	---	---
UPG - U	---	---	---	---	---	---	---	---
UPG - V	---	---	---	---	---	---	---	---
UPG - W	---	---	---	---	---	---	---	---
UPG - Y	---	---	---	---	---	---	---	---
UPG - Z	---	---	---	---	---	---	---	---
UPG - BG	---	---	---	---	---	---	---	---
UPG - D3	---	---	---	---	---	---	---	---

REV	DATE	DESCRIPTION	ECO	BY	C'HK.
B	07/30/2014	DRAWING RELEASED	37118	RK	MB





TO ORDER BURNDY® PRODUCTS CALL		INSPECTION GAGE	
UNITED STATES		ITEM NO: N/A	
1-800-346-4175 (LONDONDERRY, NH)		CAT. NO: UPG (TABLE)	
CANADA:		DRAWN BY: rkonathale 07/30/2014	
1-800-361-6975 (QUEBEC)		CHECKER: --	
1-800-387-6487 (ALL OTHER PROVINCES)		DSN APRVL: P WASON 09/06/2014	
FOR PRODUCT INFO: http://www.burndy.com		MFG APRVL: W BENEDICT 09/08/2014	
		QA APRVL: C LINDQUIST 09/08/2014	
		MKT APRVL: --	
		PROD FARM: --	
		PROJECT #: --	
		DRAWING NO	
		WCS83822	
		REV	
		B	
		SHEET 18 OF 50	

GAGE CAT. NO.	FIG. NO.	"A" GO GAGE DIA.		"B" NO GO GAGE DIA.		DIE SET CAT. NO.	DIE SET "G" DIM.	COLOR DOT PER MUNSELL COLOR CHART
		SIZE	TOL. <1	SIZE	TOL. <1			
UPG7	1	.2220 [5.638]	+0.002/-0.000	.2540 [6.452]	+0.000/-0.002	U5CRT	.242 [6.45] .254 [7.62]	BLUE - 7.58 MAX. - 10
UPG8	1	.2680 [6.807]	+0.002/-0.000	.3000 [7.620]	+0.000/-0.002	U4CRT	.288 [8.23] .300 [9.40]	GRAY - N6.0/0-N5/0
UPG9	1	.2960 [7.518]	+0.002/-0.000	.3240 [8.230]	+0.000/-0.002	U3CRT	.316 [10.06] .324 [11.38]	WHITE - 9.5
UPG10	1	.3380 [8.585]	+0.002/-0.000	.3700 [9.398]	+0.000/-0.002	U2CRT	.358 [12.40] .370 [13.56]	BROWN - 5YR4/10 - 5YR3/6
UPG11-B	4	.3680 [9.347]	+0.002/-0.000	.3960 [10.058]	+0.000/-0.005	U1CRT-1/U1CRT	.388 [13.67] .396 [16.26]	GREEN - 56Y3/4 - 10GY3/2
UPG12	1	.4160 [10.566]	+0.002/-0.000	.4480 [11.379]	+0.000/-0.002	U25RT	.436 [17.78] .448 [19.05]	PINK - 5RP6/6 - 5RP6/10
UPG13	3	.4560 [11.582]	+0.002/-0.000	.4880 [12.395]	+0.000/-0.003	U26RT	.476 [20.73] .488 [22.20]	BLACK - # 5
UPG14	1	.5060 [12.852]	+0.002/-0.000	.5340 [13.564]	+0.000/-0.002	U27RT	.526 [25.71] .534 [27.94]	ORANGE - 1.25 YR6/14 - 1.25YRS/12
UPG15	1	.5060 [12.852]	+0.002/-0.000	.5380 [13.665]	+0.000/-0.002	U28RT	.526 [13.36] .538 [13.67]	PURPLE - 7.5P5/10 - 7.5P4/6
UPG16	1	.6080 [15.443]	+0.002/-0.000	.6400 [16.256]	+0.000/-0.002	U29RT	.628 [15.95] .640 [16.26]	YELLOW - 6.25Y8/12 - 5Y8/14
UPG17	1	.6700 [17.020]	+0.002/-0.000	.7000 [17.780]	+0.000/-0.002	U30RT	.690 [17.53] .700 [17.78]	WHITE - 9.5
UPG18	1	.7220 [18.339]	+0.002/-0.000	.7500 [19.050]	+0.000/-0.002	U31RT	.742 [18.85] .750 [19.05]	RED - 7.5R MAX. - 7.5R4/12
UPG19	3	.7880 [20.015]	+0.003/-0.000	.8160 [20.726]	+0.000/-0.003	U32RT	.808 [20.52] .816 [20.73]	BLUE - 7.58 MAX. - 10
UPG20	2	.8420 [21.387]	+0.003/-0.000	.8740 [22.200]	+0.000/-0.003	U34RT	.862 [21.89] .874 [22.20]	BROWN - 5YR4/10 - 5YR3/6
UPG21	---	---	---	---	---	---	---	---
UPG22	3	.9760 [24.790]	+0.003/-0.000	1.0120 [25.705]	+0.000/-0.003	U36RT	.996 [25.30] 1.012 [25.70]	GREEN - 56Y3/4 - 10GY3/2
UPG23	---	---	---	---	---	---	---	---
UPG24	3	1.0600 [26.924]	+0.003/-0.000	1.1000 [27.940]	+0.000/-0.003	U39RT	1.080 [27.43] 1.100 [27.94]	BLACK - # 5/0
UPG	---	---	---	---	---	---	---	---
UPG	---	---	---	---	---	---	---	---
UPG	---	---	---	---	---	---	---	---
UPG	---	---	---	---	---	---	---	---
UPG	---	---	---	---	---	---	---	---
UPG30	---	---	---	---	---	---	---	---

REV	DATE	DESCRIPTION	ECO	BY	CHK.
B	07/30/2014	DRAWING RELEASED	37118	RK	MB

NOTES:
 1 CATALOG NO. UPG11 SUPERSED BY UPG11-B.

TO ORDER BURNDY® PRODUCTS CALL		INSPECTION GAGE	
UNITED STATES 1-800-346-4175 (LONDONDERRY, NH)		ITEM NO: N/A	
CANADA: 1-800-361-6975 (QUEBEC) 1-800-387-6487 (ALL OTHER PROVINCES)		CAT. NO: UPG (TABLE)	
FOR PRODUCT INFO: http://www.burndy.com		DRAWN BY: rkonathala 07/30/2014	
		CHECKER: --	
		DSN APRVL: P WASON 09/06/2014	
		MFG APRVL: W BENEDET 09/08/2014	
		QA APRVL: C LINDQUIST 09/08/2014	
		MKT APRVL: --	
		PROJ FIRM: --	
		PROJECT #: --	
		DOCUMENT TYPE: SALES	
		REL LEVEL: Released	
		DRAWING NO	
		WSC83822	
		SHEET 19 OF 50	
		REV	
		B	

GAGE CAT. NO.	FIG. NO.	'A'		'B'		DIE SET CAT NO.	DIE SET 'G' DIM.	COLOR DOT PER MUNSSELL COLOR CHART
		GO GAGE		NO GO GAGE				
		SIZE	TOL 	SIZE	TOL 			
UPG31	---	---	---	---	---	---	---	---
 UPGL99	---	.9620 [24.435]	+0.002 -.0000	1.0120 [25.705]	+0.0000 -.0002	U38XRT	1.012 [25.70] .982 [24.94]	PINK 5RP6/6 - 5RP 6/10
 UPGL115	---	1.1040 [28.042]	+0.002 -.0000	1.1580 [29.413]	+0.0000 -.0002	U44XRT	1.158 [29.41] 1.124 [28.55]	YELLOW 6.25Y8/12 - 54 8/14
UPG49	1	.1860 [4.724]	+0.002 -.0000	.2140 [5.436]	+0.0000 -.0002	U80RT	.206 [5.23] .214 [5.44]	RED 7.5RMAX. - 7.5R 4/12
UPG54	---	---	---	---	---	---	---	---

REV	DATE	DESCRIPTION	ECO	BY	CHK.
B	07/30/2014	DRAWING RELEASED	37118	RK	MB

NOTE :
 GAGE DRAWINGS NOT COMPLETED.

TO ORDER BURNDY® PRODUCTS CALL		INSPECTION GAGE	
UNITED STATES 1-800-346-4175 (LONDONDERRY, NH)		ITEM NO: N/A	
CANADA: 1-800-361-6975 (QUEBEC)		CAT. NO: UPG (TABLE)	
1-800-387-6487 (ALL OTHER PROVINCES)		DRAWN BY: rkonathala 07/30/2014	
FOR PRODUCT INFO: http://www.burndy.com		CHECKER: --	
		DSN APRVL: P WASON 09/06/2014	
		MFG APRVL: W BENEDET 09/08/2014	
		QA APRVL: C LINDQUIST 09/08/2014	
		MKT APRVL: --	
		PROD FARM: --	
		PROJECT #: --	
		DRAWING NO	
		SIZE	REV
		B	WSC83822 B
		DOCUMENT TYPE: SALES	SHEET 20 OF 50
		REL LEVEL: Released	

GAGE CAT. NO.	FIG. NO.	'A'		'B'		DIE SET CAT NO.	DIE SET 'G' DIM.	COLOR DOT PER MUNSELL COLOR CHART
		GO GAGE		NO GO GAGE				
		SIZE	TOL.	SIZE	TOL.			
UPG151	---	---	---	---	---	---	---	---
UPG155	---	---	---	---	---	---	---	---
UPG160	---	---	---	---	---	---	---	---
UPG163	3	.4260 [10.820]	+0.002 -0.0000	.4540 [11.532]	+0.0000 -0.0002	U163	.446 [11.33] .454 [11.53]	NO REQ.
UPG165	1	.5300 [13.462]	+0.002 -0.0000	.5600 [14.224]	+0.0000 -0.0002	U165/205	.550 [13.97] .560 [14.22]	NO REQ.
UPG167	1	.6380 [16.205]	+0.002 -0.0000	.6680 [16.967]	+0.0000 -0.0002	U167, U568	.658 [16.71] .668 [16.97]	NO REQ.
UPG168	2	.7340 [18.644]	+0.002 -0.0000	.7640 [19.406]	+0.0000 -0.0002	U168	.754 [19.15] .764 [19.41]	NO REQ.
UPG170	4	.9240 [23.470]	+0.0005 -0.0000	.9540 [24.232]	+0.0000 -0.0005	U770	.944 [23.98] .954 [24.23]	NO REQ.
UPG174	---	---	---	---	---	---	---	---

REV	DATE	DESCRIPTION	ECO	BY	CHK.
B	07/30/2014	DRAWING RELEASED	37118	RK	MB

TO ORDER BURNDY® PRODUCTS CALL		INSPECTION GAGE	
UNITED STATES		ITEM NO: N/A	
1-800-346-4175 (LONDONDERRY, NH)		CAT. NO: UPG (TABLE)	
CANADA:		DRAWN BY: rkonathale 07/30/2014	
1-800-361-6975 (QUEBEC)		CHECKER: --	
1-800-387-6487 (ALL OTHER PROVINCES)		DSN APRVL: P WASON 09/06/2014	
FOR PRODUCT INFO: http://www.burndy.com		MFG APRVL: W BENEDICT 09/08/2014	
		QA APRVL: C LINDQUIST 09/08/2014	
		MKT APRVL: --	
		PROD FARM: --	
		PROJECT #: --	
		DRAWING NO	
		WSC83822	
		REV	
		B	
		SHEET 21 OF 50	

GAGE CAT. NO.	FIG. NO.	'A'		'B'		DIE SET CAT NO.	DIE SET 'G' DIM.	COLOR DOT PER MUNSSELL COLOR CHART
		GO GAGE		NO GO GAGE				
		SIZE	TOL.	SIZE	TOL.			
UPG199	---	---	---	---	---	---	---	---
UPG200	---	---	---	---	---	---	---	---
UPG205	---	---	---	---	---	---	---	---
UPG209	2	1.0080 [25.603]	+0.0003 -0.0000	1.0480 [26.619]	+0.0000 -0.0003	U209	1.028 [26.11] 1.048 [26.62]	NO REQ.
UPG210	---	---	---	---	---	---	---	---
UPG215	---	---	---	---	---	---	---	---
UPG220	---	---	---	---	---	---	---	---
UPG222	---	---	---	---	---	---	---	---



REV	DATE	DESCRIPTION	ECO	BY	CHK.
B	07/30/2014	DRAWING RELEASED	37118	RK	MB

TO ORDER BURNDY® PRODUCTS CALL		INSPECTION GAGE	
UNITED STATES		ITEM NO: N/A	
1-800-346-4175 (LONDONDERRY, NH)		CAT. NO: UPG (TABLE)	
CANADA:		DRAWN BY: rkonathale 07/30/2014	
1-800-361-6975 (QUEBEC)		CHECKER: --	
1-800-387-6487 (ALL OTHER PROVINCES)		DSN APRVL: P WASON 09/06/2014	
FOR PRODUCT INFO: http://www.burndy.com		MFG APRVL: W BENEDICT 09/08/2014	
		QA APRVL: C LINDQUIST 09/08/2014	
		MKT APRVL: --	
		PROD FIRM: --	
		PROJECT #: --	
		DRAWING NO	
		WSC83822	
		REV	
		B	
		SHEET 22 OF 50	

GAGE CAT. NO.	FIG. NO.	'A'		'B'		DIE SET CAT NO.	DIE SET 'G' DIM.	COLOR DOT PER MUNSSELL COLOR CHART
		GO GAGE		NO GO GAGE				
		SIZE	TOL.	SIZE	TOL.			
UPG295	1	.4000 [25.603]	+0.002 -0.000	.4280 [10.871]	+0.000 -0.002	U2CART	.420 [10.67] .428 [10.87]	NO REQT.
UPG296	4	.4780 [26.619]	+0.002 -0.000	.5060 [12.852]	+0.000 -0.002	U25ART	.498 [12.65] .506 [12.85]	TAN 2.5YR 5/12 - 2.5YR 5/10
UPG297	1	.5420 [13.767]	+0.002 -0.000	.5700 [14.478]	+0.000 -0.002	U26ART	.562 [14.27] .570 [13.20]	OLIVE 56Y 6/8 - 56Y 6/6
UPG298	1	.6880 [26.110]	+0.002 -0.000	.7160 [18.186]	+0.000 -0.002	U28ART	.708 [18.00] .716 [18.18]	WHITE N9.5
UPG299	2	.8700 [26.620]	+0.002 -0.000	.9060 [23.012]	+0.000 -0.002	U31ART	.890 [22.60] .906 [23.01]	BROWN 5YR 4/10 - 5YR 3/6
UPG300	2	1.0480 [26.619]	+0.002 -0.000	1.0840 [27.534]	+0.000 -0.002	U34ART	1.068 [27.12] 1.084 [27.53]	PINK 5RP 6/6 - 5RP 6/10
UPG318	---	---	---	---	---	---	---	---

REV	DATE	DESCRIPTION	ECO	BY	CHK.
B	07/30/2014	DRAWING RELEASED	37118	RK	MB

TO ORDER BURNDY® PRODUCTS CALL		INSPECTION GAGE	
UNITED STATES		ITEM NO: N/A	
1-800-346-4175 (LONDONDERRY, NH)		CAT. NO: UPG (TABLE)	
CANADA:		DRAWN BY: rkonathala 07/30/2014	
1-800-361-6975 (QUEBEC)		CHECKER: --	
1-800-387-6487 (ALL OTHER PROVINCES)		DSN APRVL: P WASON 09/06/2014	
FOR PRODUCT INFO: http://www.burndy.com		MFG APRVL: W BENEDET 09/08/2014	
		QA APRVL: C LINDQUIST 09/08/2014	
		MKT APRVL: --	
		PROD FARM: --	
		PROJECT #: --	
		DOCUMENT TYPE: SALES	
		REL LEVEL: Released	
		DRAWING NO	
		W5C83822	
		SHEET 23 OF 50	
		REV	
		B	

GAGE CAT. NO.	FIG. NO.	'A'		'B'		DIE SET CAT NO.	DIE SET 'G' DIM.	COLOR DOT PER MUNSSELL COLOR CHART
		GO GAGE		NO GO GAGE				
		SIZE	TOL. 	SIZE	TOL. 			
UPG319	---	---	---	---	---	---	---	---
UPG324	4	.7500 [25.603]	+0.0005 -0.0000	.7780 [26.110]	+0.0000 -0.0005	U29ART	.770 [19.56] .778 [19.76]	RED 7.5R MAX. - 7.5R 4/12
UPG340	1	.2400 [26.619]	+0.0002 -0.0000	.2680 [26.620]	+0.0000 -0.0002	U4CET	.260 [6.60] .268 [6.80]	NO REQ.
UPG342	---	---	---	---	---	---	---	---

REV	DATE	DESCRIPTION	ECO	BY	CHK.
B	07/30/2014	DRAWING RELEASED	37118	RK	MB

TO ORDER BURNDY® PRODUCTS CALL		INSPECTION GAGE	
UNITED STATES		ITEM NO: N/A	
1-800-346-4175 (LONDONDERRY, NH)		CAT. NO: UPG (TABLE)	
CANADA:		DRAWN BY: rkonathala 07/30/2014	
1-800-361-6975 (QUEBEC)		CHECKER: --	
1-800-387-6487 (ALL OTHER PROVINCES)		DSN APRVL: P WASON 09/06/2014	
FOR PRODUCT INFO: http://www.burndy.com		MFG APRVL: W BENEICT 09/08/2014	
		QA APRVL: CLINDQUIST 09/08/2014	
		MKT APRVL: --	
		PROD FARM: --	
		PROJECT #: --	
		DRAWING NO	
		WSC83822	
		REV	
		B	
		SHEET 24 OF 50	

GAGE CAT. NO.	FIG. NO.	'A'		'B'		DIE SET CAT NO.	DIE SET 'G' DIM.	COLOR DOT PER MUNSSELL COLOR CHART
		GO GAGE		NO GO GAGE				
		SIZE	TOL.	SIZE	TOL.			
UPG343	---	---	---	---	---	---	---	---
UPG345	---	---	---	---	---	---	---	---
UPG346	3	.2540 [25.603]	+0.001 -0.002	.2820 [19.558]	+0.000 -0.001	U6CABT	.274 [6.96] .282 [7.16]	GRAY N5.51 - N4.01
UPG348	3	.4100 [26.619]	+0.002 -0.000	.4380 [19.761]	+0.000 -0.002	U2CABT	.430 [11.00] .438 [11.13]	PINK 5RP 6/6 - 5RP 6/10
UPG350	---	---	---	---	---	---	---	---
UPG353	4	.3880 [9.855]	+0.005 -0.000	.4160 [6.604]	+0.000 -0.005	U2CET	.408 [10.36] .416 [10.57]	NO REQ.
UPG355	4A	.1720 [26.110]	+0.005 -0.000	.2000 [6.807]	+0.000 -0.005	U8CET	.192 [4.88] .200 [5.08]	NO REQ.
UPG356	1	.1940 [26.620]	+0.002 -0.000	.2220 [5.639]	+0.000 -0.002	U6CET	.214 [5.44] .222 [5.64]	NO REQ.
UPG360	---	---	---	---	---	---	---	---
UPG366	---	---	---	---	---	---	---	---

REV	DATE	DESCRIPTION	ECO	BY	CHK.
B	07/30/2014	DRAWING RELEASED	37118	RK	MB

TO ORDER BURNDY® PRODUCTS CALL		INSPECTION GAGE	
UNITED STATES		ITEM NO: N/A	
1-800-346-4175 (LONDONDERRY, NH)		CAT. NO: UPG (TABLE)	
CANADA:		DRAWN BY: rkonathala 07/30/2014	
1-800-361-6975 (QUEBEC)		CHECKER: --	
1-800-387-6487 (ALL OTHER PROVINCES)		DSN APRVL: P WASON 09/06/2014	
FOR PRODUCT INFO: http://www.burndy.com		MFG APRVL: W BENEICT 09/08/2014	
		QA APRVL: C LINDQUIST 09/08/2014	
		MKT APRVL: --	
		PROD FARM: --	
		PROJECT #: --	
		DOCUMENT TYPE: SALES	
		REL LEVEL: Released	
		DRAWING NO	
		WSC83822	
		SHEET 25 OF 50	
		REV	
		B	

GAGE CAT. NO.	FIG. NO.	'A'		'B'		DIE SET CAT NO.	DIE SET 'G' DIM.	COLOR DOT PER MUNSSELL COLOR CHART
		GO GAGE		NO GO GAGE				
		SIZE	TOL. \triangleleft 1	SIZE	TOL. \triangleleft 1			
UPG367	---	---	---	---	---	---	---	---
UPG370	---	---	---	---	---	---	---	---
UPG375	3	.3260 [25.603]	+0.0002 -0.0000	.3540 [26.619]	+0.0000 -0.0002	U4CABT	.346 [26.11] .354 [26.62]	GREEN 5GY 3/4 - 10GY 3/2
UPG380	---	---	---	---	---	---	---	---
UPG385	---	---	---	---	---	---	---	---
UPG390	---	---	---	---	---	---	---	---

REV	DATE	DESCRIPTION	ECO	BY	CHK.
B	07/30/2014	DRAWING RELEASED	37118	RK	MB

TO ORDER BURNDY® PRODUCTS CALL		INSPECTION GAGE	
UNITED STATES		ITEM NO: N/A	
1-800-346-4175 (LONDONDERRY, NH)		CAT. NO: UPG (TABLE)	
CANADA:		DRAWN BY: rkonathale 07/30/2014	
1-800-361-6975 (QUEBEC)		CHECKER: --	
1-800-387-6487 (ALL OTHER PROVINCES)		DSN APRVL: P WASON 09/06/2014	
FOR PRODUCT INFO: http://www.burndy.com		MFG APRVL: W BENEDICT 09/08/2014	
		QA APRVL: C LINDQUIST 09/08/2014	
		MKT APRVL: --	
		PROD FARM: --	
		PROJECT #: --	
		DOCUMENT TYPE: SALES	
		REL LEVEL: Released	
		DRAWING NO	
		W5C83822	
		SHEET 26 OF 50	
		REV	
		B	

GAGE CAT. NO.	FIG. NO.	'A'		'B'		DIE SET CAT NO.	DIE SET 'G' DIM.	COLOR DOT PER MUNSSELL COLOR CHART
		GO GAGE		NO GO GAGE				
		SIZE	TOL.	SIZE	TOL.			
UPG463	---	---	---	---	---	---	---	---
UPG467	4	.6100 [15.494]	+0.0005 -0.0000	.6380 [16.205]	+0.0000 -0.0005	U27ART	.630 [16.00] .638 [16.36]	RUBY 5R 3/10 - 5R 3/6
UPG470	4	.8220 [20.879]	+0.0005 -0.0000	.8500 [21.590]	+0.0000 -0.0005	U30ART	.842 [21.39] .850 [21.59]	BLUE 7.58 MAX. - 10
UPG471	4	.4260 [10.820]	+0.0005 -0.0000	.4540 [11.532]	+0.0000 -0.0005	U1CART	.446 [11.33] .454 [11.53]	GOLD 2.5Y 6/10 - 2.5Y 7/12
UPG472	2	.9440 [23.978]	+0.0002 -0.0000	.9800 [24.892]	+0.0000 -0.0002	U32ATR	.964 [24.49] .980 [24.89]	GREEN 56Y 3/4 - 10GY 3/2
UPG473	2	1.1640 [29.566]	+0.0003 -0.0000	1.2020 [30.531]	+0.0000 -0.0003	U36ART	1.184 [30.07] 1.202 [30.53]	BLACK N5.0
UPG936	2	1.1180 [28.397]	+0.0003 -0.0000	1.1580 [29.413]	+0.0000 -0.0003	U39ART-2	1.138 [28.91] 1.158 [29.41]	YELLOW 6.25Y 8/12 - 5Y 8/14
UPG486	---	---	---	---	---	---	---	---

REV	DATE	DESCRIPTION	ECO	BY	C'HK.
B	07/30/2014	DRAWING RELEASED	37118	RK	MB

TO ORDER BURNDY® PRODUCTS CALL		INSPECTION GAGE	
UNITED STATES		ITEM NO: N/A	
1-800-346-4175 (LONDONDERRY, NH)		CAT. NO: UPG (TABLE)	
CANADA:		DRAWN BY: rkonathala 07/30/2014	
1-800-361-6975 (QUEBEC)		CHECKER: --	
1-800-387-6487 (ALL OTHER PROVINCES)		DSN APRVL: P WASON 09/06/2014	
FOR PRODUCT INFO: http://www.burndy.com		MFG APRVL: W BENEICT 09/08/2014	
		QA APRVL: C LINDQUIST 09/08/2014	
		MKT APRVL: --	
		PROD FARM: --	
		PROJECT #: --	
		DOCUMENT TYPE: SALES	
		REL LEVEL: Released	
		DRAWING NO	
		W5C83822	
		SHEET 27 OF 50	
		REV	
		B	

GAGE CAT. NO.	FIG. NO.	'A'		'B'		DIE SET CAT NO.	DIE SET 'G' DIM.	COLOR DOT PER MUNSELL COLOR CHART
		GO GAGE		NO GO GAGE				
		SIZE	TOL. <1	SIZE	TOL. <1			
UPG991	---	---	---	---	---	---	---	---
UPG997	4	1.2240 [31.090]	+0.0005 -0.0000	1.2600 [32.004]	+0.0000 -0.0005	U997	1.244 [31.60] 1.260 [32.00]	NO REQ.
UPG1014	---	---	---	---	---	---	---	---

REV	DATE	DESCRIPTION	ECO	BY	CHK.
B	07/30/2014	DRAWING RELEASED	37118	RK	MB

TO ORDER BURNDY® PRODUCTS CALL		INSPECTION GAGE	
UNITED STATES		ITEM NO: N/A	
1-800-346-4175 (LONDONDERRY, NH)		CAT. NO: UPG (TABLE)	
CANADA:		DRAWN BY: rkonathale 07/30/2014	
1-800-361-6975 (QUEBEC)		CHECKER: --	
1-800-387-6487 (ALL OTHER PROVINCES)		DSN APRVL: P WASON 09/06/2014	
FOR PRODUCT INFO: http://www.burndy.com		MFG APRVL: W BENEDICT 09/08/2014	
		QA APRVL: C LINDQUIST 09/08/2014	
		MKT APRVL: --	
		PROD FAM: --	
		PROJECT #: --	
		DRAWING NO	
		WCS83822	
		REV	
		B	
		SHEET 28 OF 50	

REV	DATE	DESCRIPTION	ECO	BY	CHK.
B	07/30/2014	DRAWING RELEASED	37118	RK	MB

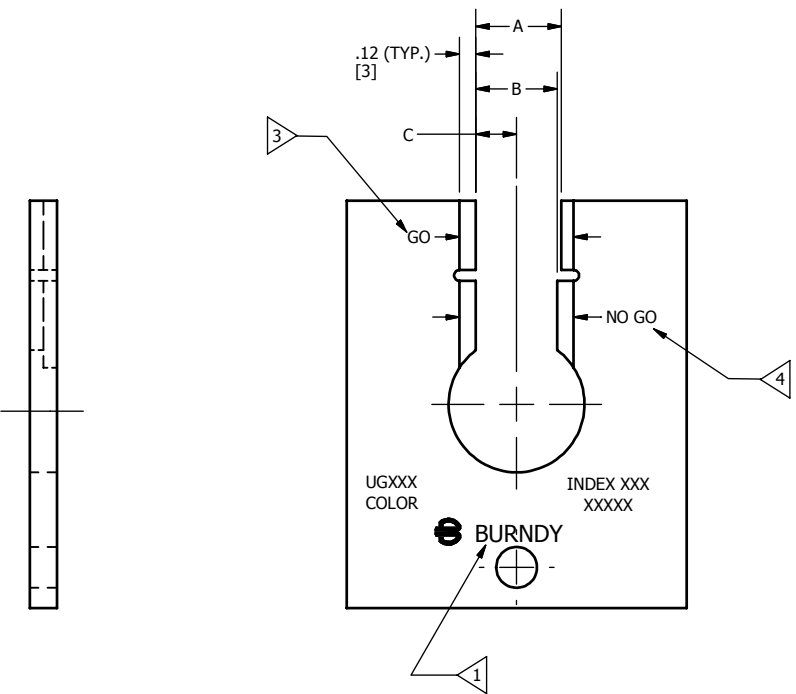
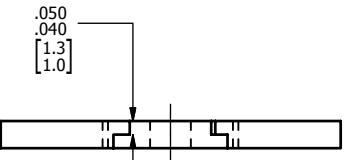

NOTES :

- 1 > SYMBOL & LOGO PER BURNDY SPEC. L-116, TYPE1. SIZE 21.
- 2. ALL OTHER LETTERING TO BE ENGRAVED OR STAMPED.
SIZE : .12
STYLE: STANDARD GOTHIC.
- 3 > WORD 'GO' AND CORRESPONDING ARROWS TO BE FILLED WITH GREEN PAINT STIK.
- 4 > WORD 'NO GO' AND CORRESPONDING ARROWS TO BE FILLED WITH RED PAINT STIK.
- 5. SEE TABLE FOR PROPER UG NO. INDEX NO. AND COLOR.
FILL 1/8 X 1/2 DEPRESSION (OR 1/8 DIA. C SINK) WITH CORRESPONDING PAINT STICK.

TO ORDER BURNDY® PRODUCTS CALL		INSPECTION GAGE	
UNITED STATES		ITEM NO: N/A	
1-800-346-4175 (LONDONDERRY, NH)		CAT. NO: UG (TABLE)	
CANADA:		DRAWN BY: rkonathale 07/30/2014	
1-800-361-6975 (QUEBEC)		CHECKER: --	
1-800-387-6487 (ALL OTHER PROVINCES)		DSN APRVL: P WASON 09/06/2014	
FOR PRODUCT INFO: http://www.burndy.com		MFG APRVL: W BENEICT 09/08/2014	
		QA APRVL: C LINDQUIST 09/08/2014	
		MKT APRVL: --	
		PROD FARM: --	
		PROJECT #: --	
		DOCUMENT TYPE: SALES	
		REL LEVEL: Released	
		DRAWING NO	
		WSC83822	
		SHEET 29 OF 50	
		REV	
		B	

CUSTOMER NAME	INDEX NO. USED BY CUSTOMER
CALLAWAY NUCLEAR FACILITY	UG7, 8, 9, 10, 11, 12, 13, 14, 15, 16, 17, 18, 19, 20, 22, 24, 49
WOLF CREEK NUCLEAR FACILITY	UG7, 8, 9, 10, 11, 12, 13, 14, 15, 16, 17, 18, 19, 20, 22, 24, 49
SOUTH TEXAS NUCLEAR FACILITY	UG7, 8, 10, 12, 13, 15, 16, 18, 20, 24, 49
BETHEL POWER CORP - SANATOGA	UG8, 10, 11, 12, 13, 15, 16, 18, 20, 24, 49

REV	DATE	DESCRIPTION	ECO	BY	CHK.
B	07/30/2014	DRAWING RELEASED	37118	RK	MB

NOTES :

THIS SHEET IS FOR BURNDY PERSONEL ONLY. IT IS NOT TO BE ISSUED TO ANY CUSTOMER.

TO ORDER BURNDY® PRODUCTS CALL		CUSTOMER REFERENCE LIST	
UNITED STATES 1-800-346-4175 (LONDONDERRY, NH)		ITEM NO: N/A	
CANADA: 1-800-361-6975 (QUEBEC) 1-800-387-6487 (ALL OTHER PROVINCES)		CAT. NO: UG (TABLE)	
FOR PRODUCT INFO: http://www.burndy.com		DRAWN BY: rkonathala 07/30/2014	
		CHECKER: --	
		DSN APRVL: P WASON 09/06/2014	
		MFG APRVL: W BENEDICT 09/08/2014	
		QA APRVL: C LINDQUIST 09/08/2014	
		MKT APRVL: --	
		PROD FARM: --	
		PROJECT #: --	
		DOCUMENT TYPE: SALES	
		REL LEVEL: Released	
		DRAWING NO	
		WCS83822	
		SHEET 30 OF 50	
		REV	
		B	



DIE INDEX NO.	GAGE CAT. NO.	DIE SET CAT. NO.	GAGE DIMENSIONS			LETTERING	GAGE BLANK NO.	COLOR CODE	DIE SET 'G' DIM. REF.
			C ± .02	B +.003 -.000	A +.000 -.003				
7	UG7	U5CRT	.11 [2.8]	.226 [5.74]	.261 [6.63]	UG7 INDEX 7	12832	BLUE 7.5 B MAX. - 10 .246 [6.25] .254 [6.45]	
8	UG3	U4CRT	.14 [3.6]	.272 [6.91]	.307 [7.8]	UG8 INDEX 8	12832	GRAY N6.0/0 - N5.0/0 .292 [7.42] .300 [7.62]	
9	UG9	U3CRT	.15 [3.8]	.296 [7.52]	.331 [8.41]	UG9 INDEX 9	12832	WHITE 9.5 .316 [8.03] .334 [8.48]	
10	UG10	U2CRT	.17 [4.3]	.342 [8.69]	.377 [9.58]	UG10 INDEX 10	12832	BROWN 5YR 4/10 - 5YR 3/6 .362 [9.19] .370 [9.40]	
11	UG11	U1CRT - 1 U1CRT	.18 [4.6]	.368 [9.35]	.403 [10.24]	UG11 INDEX 11	12832	GREEN 5GY 3/4 - 10GY 3/2 .388 [9.86] .396 [10.06]	
12	UG12	U25RT	.21 [5.3]	.420 [10.67]	.455 [11.56]	UG12 INDEX 12	12832	PINK 5RP 6/6 - 5RP 6/10 .440 [11.18] .448 [11.38]	
13	UG13	U26RT	.23 [5.8]	.460 [11.68]	.495 [12.57]	UG13 INDEX 13	12832	BLACK #5 .480 [12.19] .488 [12.40]	
14	UG14	U27RT	.25 [6.4]	.506 [12.85]	.541 [13.74]	UG14 INDEX 14	12832	ORANGE 1.25YR 6/14 - 1.25YR 5/12 .526 [13.36] .534 [13.56]	
15	UG15	U28RT	.25 [6.4]	.510 [12.95]	.545 [13.84]	UG15 INDEX 15	12832	PURPLE 7.5P 5/10 - 7.5P 4/6 .530 [13.46] .538 [13.67]	
16	UG16	U29RT	.31 [7.9]	.612 [15.54]	.647 [16.43]	UG16 INDEX 16	12832	YELLOW 6.25Y 8/12 - 5Y 8/14 .632 [16.05] .640 [16.26]	
17	UG17	U30RT	.34 [8.6]	.672 [17.07]	.709 [18.01]	UG17 INDEX 17	12832	WHITE 9.5 .692 [17.58] .700 [17.78]	
18	UG18	U31RT	.36 [9.1]	.722 [18.34]	.763 [19.38]	UG18 INDEX 18	12832	RED 7.5R MAX. - 7.5R 4/12 .742 [18.85] .750 [19.05]	
19	UG19	U32RT	.39 [9.9]	.788 [20.02]	.893 [22.68]	UG19 INDEX 19	12832	BLUE 7.5 B MAX. - 10 .808 [20.52] .816 [20.73]	
20	UG20	U34RT	.42 [10.7]	.844 [21.44]	.930 [23.62]	UG20 INDEX 20	12832	BROWN 5YR 4/10 - 5YR 3/6 .864 [21.95] .874 [22.20]	
22	UG22	U36RT	.49 [12.4]	.976 [24.79]	1.099 [27.91]	UG22 INDEX 22	12832	GREEN 5GY 3/4 - 10GY 3/2 .996 [25.30] 1.012 [25.70]	
24	UG24	U39RT	.53 [13.5]	1.060 [26.92]	1.153 [29.29]	UG24 INDEX 24	12832	BLACK #5/0 1.080 [27.43] 1.100 [27.94]	
49	UG49	U8CRT	.09 [2.286]	.186 [4.72]	.224 [5.69]	UG49 INDEX 49	12832	RED 7.5R MAX. - 7.5R 4/12 .206 [5.23] .214 [5.44]	

REV	DATE	DESCRIPTION	ECO	BY	C'HK.
B	07/30/2014	DRAWING RELEASED	37118	RK	MB

TO ORDER BURNDY® PRODUCTS CALL		INSPECTION GAGE	
UNITED STATES 1-800-346-4175 (LONDONDERRY, NH)		ITEM NO: N/A	
CANADA: 1-800-361-6975 (QUEBEC) 1-800-387-6487 (ALL OTHER PROVINCES)		CAT. NO: LG (TABLE)	
FOR PRODUCT INFO: http://www.burndy.com		DRAWN BY: rkonathala	07/30/2014
		CHECKER: --	
		DSN APRVL: P WASON	09/06/2014
		MFG APRVL: W BENEICT	09/08/2014
		QA APRVL: C LINDQUIST	09/08/2014
		MKT APRVL: --	
		PROD FARM: --	
		PROJECT #: --	
		DOCUMENT TYPE: SALES	
		REL LEVEL: Released	
		DRAWING NO	REV
		W5C83822	B
		SHEET 31 OF 50	

REV	DATE	DESCRIPTION	ECO	BY	CHK.
B	07/30/2014	DRAWING RELEASED	37118	RK	MB

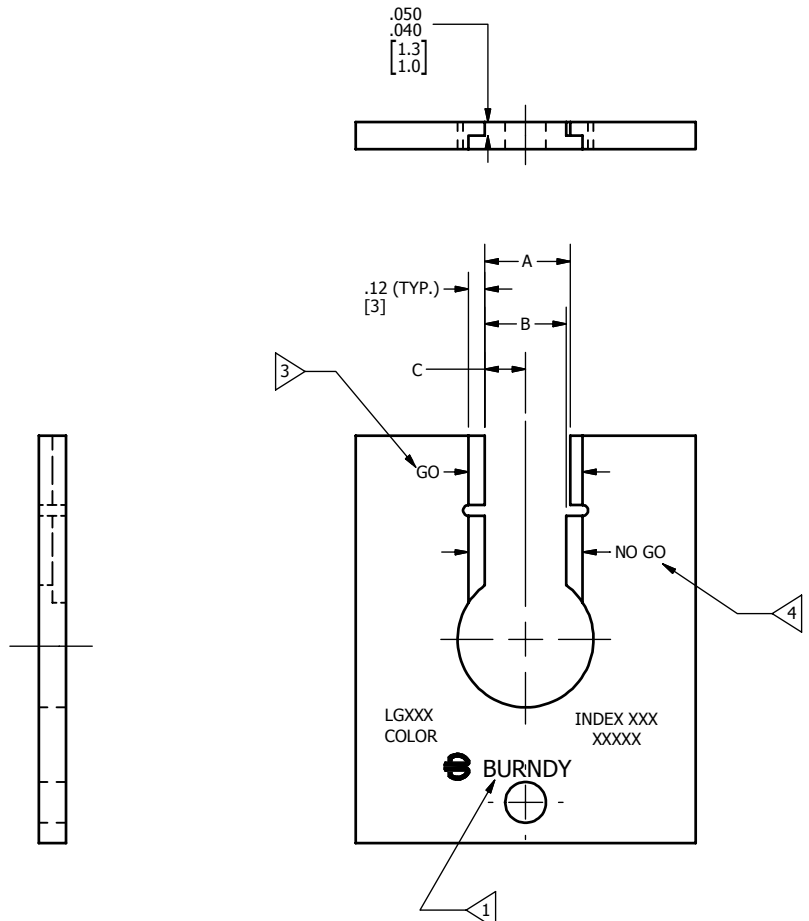

NOTES :

- 1 SYMBOL & LOGO PER BURNDY SPEC. L-116, TYPE1. SIZE 21.
- 2. ALL OTHER LETTERING TO BE ENGRAVED OR STAMPED.
SIZE : .12
STYLE: STANDARD GOTHIC.
- 3 WORD 'GO' AND CORRESPONDING ARROWS TO BE FILLED WITH GREEN PAINT STIK.
- 4 WORD 'NO GO' AND CORRESPONDING ARROWS TO BE ILLED WITH RED PAINT STIK.
- 5. SEE TABLE FOR PROPER UG NO. INDEX NO. AND COLOR.
FILL 1/8 X 1/2 DEPRESSION (OR 1/8 DIA. C SINK) WITH CORRESPONDING PAINT STICK.

TO ORDER BURNDY® PRODUCTS CALL		INSPECTION GAGE	
UNITED STATES		ITEM NO: N/A	
1-800-346-4175 (LONDONDERRY, NH)		CAT. NO: LG (TABLE)	
CANADA:		DRAWN BY: rkonathala 07/30/2014	
1-800-361-6975 (QUEBEC)		CHECKER: --	
1-800-387-6487 (ALL OTHER PROVINCES)		DSN APRVL: P WASON 09/06/2014	
FOR PRODUCT INFO: http://www.burndy.com		MFG APRVL: W BENEICT 09/08/2014	
		QA APRVL: C LINDQUIST 09/08/2014	
		MKT APRVL: --	
		PROJ FIRM: --	
		PROJECT #: --	
		DOCUMENT TYPE: SALES	
		REL LEVEL: Released	
		DRAWING NO	
		WSC83822	
		SHEET 32 OF 50	
		REV	
		B	

CUSTOMER NAME	INDEX NO. USED BY CUSTOMER
CALLAWAY NUCLEAR FACILITY	LG27, 34
WOLF CREEK NUCLEAR FACILITY	LG27, 34
PEACH BOTTOM POWER STA.	LG24
BECHTEL POWER CORP. POTTSTOWN PA.	LG27, 33 & 479

REV	DATE	DESCRIPTION	ECO	BY	CHK.
B	07/30/2014	DRAWING RELEASED	37118	RK	MB

NOTE :

THIS SHEET IS FOR BURNDY PERSONEL ONLY IT IS NOT TO BE ISSUED TO ANY CUSTOMER.

TO ORDER BURNDY® PRODUCTS CALL		CUSTOMER REFERENCE LIST	
UNITED STATES 1-800-346-4175 (LONDONDERRY, NH)		ITEM NO: N/A	
CANADA: 1-800-361-6975 (QUEBEC) 1-800-387-6487 (ALL OTHER PROVINCES)		CAT. NO: LG (TABLE)	
FOR PRODUCT INFO: http://www.burndy.com		DRAWN BY: rkonathale 07/30/2014	
		CHECKER: --	
		DSN APRVL: P WASON 09/06/2014	
		MFG APRVL: W BENEDICT 09/08/2014	
		QA APRVL: C LINDQUIST 09/08/2014	
		MKT APRVL: --	
		PROD FIRM: --	
		PROJECT #: --	
		SIZE	
		B	
		REL LEVEL: Released	
		DRAWING NO	
		WSC83822	
		REV	
		B	
		SHEET 33 OF 50	



DIE INDEX NO.	GAGE CAT. NO.	DIE SET CAT. NO.	GAGE DIMENSIONS			LETTERING	GAGE BLANK NO.	COLOR CODE	DIE SET 'G' DIM. REF.
			C ± .02	B +.003 -.000	A +.000 -.003				
27	LG27	L44RT	.64 [16.3]	1.274 [32.40]	1.313 [33.35]	LG27 INDEX 27	12833	WHITE #N 9.5	1.294 [32.87] 1.302 [33.07]
34	LG34	L48RT	.91 [23.1]	1.816 [46.10]	1.855 [47.12]	LG34 INDEX 34	12833	BROWN 5YR 4/10 - 5YR 3/6	1.836 [46.63] 1.844 [46.84]
24	LG24	L39RT	.55 [14.0]	1.086 [27.60]	1.171 [29.74]	LG24 INDEX 24	12833	NO REQ.	1.106 [28.09] 1.114 [28.30]
33	LG33	L47RT	.82 [20.8]	1.634 [41.50]	1.673 [42.49]	LG33 INDEX 33	12833	GRAY 6.0/0 - N5.0/0	1.654 [42.01] 1.662 [42.21]
479	LG479	L48ART	1.08 [27.4]	2.174 [55.20]	2.244 [57.00]	LG479 INDEX 479	12833	RED 7.5 MAX. - 7.5R 4/12	2.186 [55.52] 2.234 [56.74]

REV	DATE	DESCRIPTION	ECO	BY	CHK.
B	07/30/2014	DRAWING RELEASED	37118	RK	MB

TO ORDER BURNDY® PRODUCTS CALL		INSPECTION GAGE	
UNITED STATES		ITEM NO: N/A	
1-800-346-4175 (LONDONDERRY, NH)		CAT. NO: LG (TABLE)	
CANADA:		DRAWN BY: rkonathala 07/30/2014	
1-800-361-6975 (QUEBEC)		CHECKER: --	
1-800-387-6487 (ALL OTHER PROVINCES)		DSN APRVL: P WASON 09/06/2014	
FOR PRODUCT INFO: http://www.burndy.com		MFG APRVL: W BENEDET 09/08/2014	
		QA APRVL: C LINDQUIST 09/08/2014	
		MKT APRVL: --	
		PROD FARM: --	
		PROJECT #: --	
		DOCUMENT TYPE: SALES	
		REL LEVEL: Released	
		DRAWING NO	
		WSC83822	
		SHEET 34 OF 50	
		REV	
		B	

REV	DATE	DESCRIPTION	ECO	BY	CHK.
B	07/30/2014	DRAWING RELEASED	37118	RK	MB

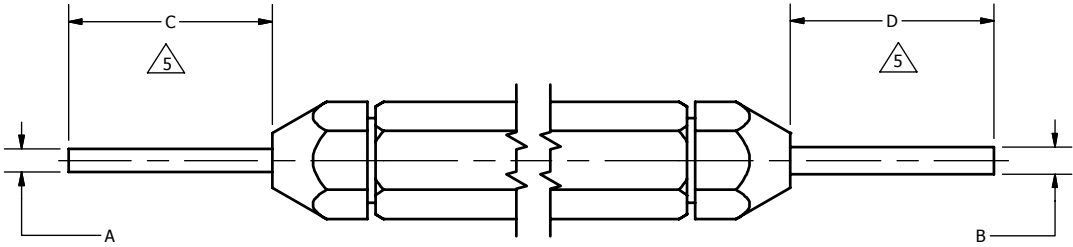
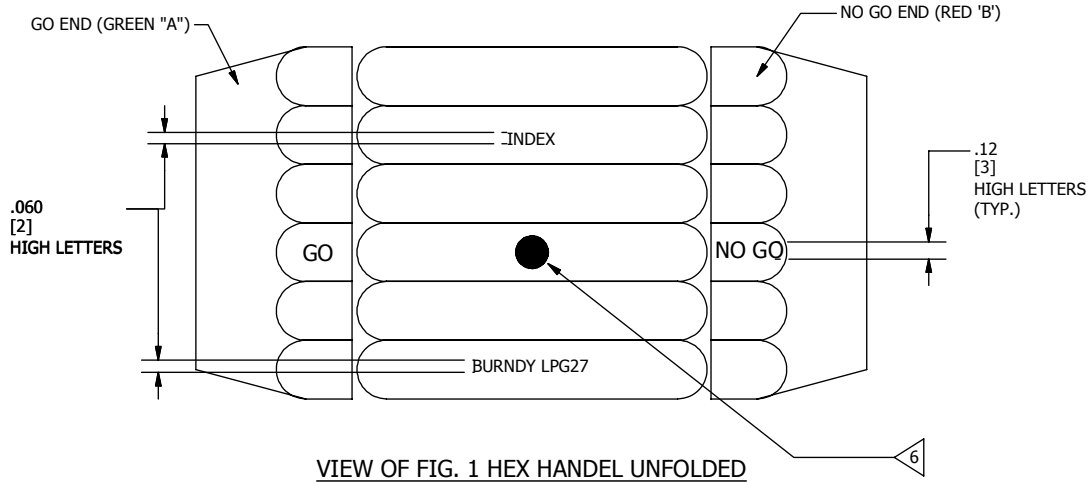

FIG. 1
(WIRE TYPE)



VIEW OF FIG. 1 HEX HANDEL UNFOLDED

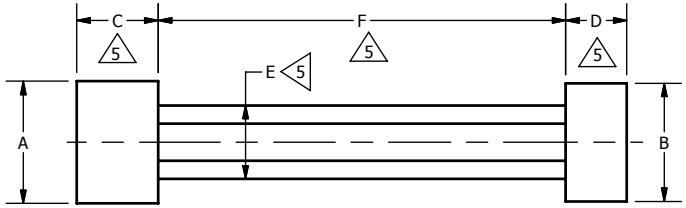
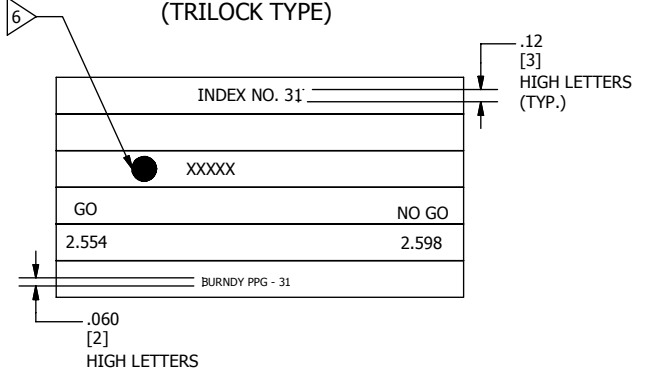

FIG. 2
(TRILOCK TYPE)



VIEW OF FIG. 2 HEX HANDEL UNFOLDED

NOTES :

- 1 TOLERANCE FOR FIG TYPES ARE AS FOLLOES:
 FIG.1 = +.0002 & -.0002
 FIG.2 = +.0003 & -.0003
 FIG.3 = +.0003 & -.0003
 FIG.4 = +.0005 & -.0005
- 4. ALL LETTERING PER BURNDY SPEC. L217 GROUP 1B. LETTERING TO BE FILLED WITH BLACK LACQUER.
- 5 DIMS. C-D-E-F ARE GAGE MFG'S STANDARD, UNLESS OTHERWISE SPECIFIED.
- 6 .12 DIA. SPOT DRILL COLOR DOT & WORD TO BE FILLED WITH PAINT STIK IN APPROPRIATE COLOR (SEE TABLE)

TO ORDER BURNDY® PRODUCTS CALL		INSPECTION GAGE	
UNITED STATES 1-800-346-4175 (LONDONDERRY, NH)		ITEM NO: N/A	
CANADA: 1-800-361-6975 (QUEBEC) 1-800-387-6487 (ALL OTHER PROVINCES)		CAT. NO: PPG (TABLE)	
FOR PRODUCT INFO: http://www.burndy.com		DRAWN BY: rkonathale 07/30/2014	
		CHECKER: --	
		DSN APRVL: P WASON 09/06/2014	
		MFG APRVL: W BENEDICT 09/08/2014	
		QA APRVL: C LINDQUIST 09/08/2014	
		MKT APRVL: --	
		PROD FAM: --	
		PROJECT #: --	
		DRAWING NO	
		WSC83822	
		SHEET 35 OF 50	
		REV	
		B	

CUSTOMER NAME	INDEX NO. USED BY CUSTOMER
WASHINGTON PUBLIC POWER SYSTEMS 1&4	PPG31, PPG 999
PHIPPS BEND NUCLEAR FACILITY	PPG998, PUPG998
TURKEY POINT NUCLEAR FACILITY FLORIDA POWER & LIGHT CO.	PPG - 25

REV	DATE	DESCRIPTION	ECO	BY	CHK.
B	07/30/2014	DRAWING RELEASED	37118	RK	MB

NOTE :

THIS SHEET IS FOR BURNDY PERSONEL ONLY IT IS NOT TO BE ISSUED TO ANY CUSTOMER.

TO ORDER BURNDY® PRODUCTS CALL		INSPECTION GAGE	
UNITED STATES 1-800-346-4175 (LONDONDERRY, NH)		ITEM NO: N/A	
CANADA: 1-800-361-6975 (QUEBEC)		CAT. NO: PPG (TABLE)	
1-800-387-6487 (ALL OTHER PROVINCES)		DRAWN BY: rkonathale 07/30/2014	
FOR PRODUCT INFO: http://www.burndy.com		CHECKER: --	
		DSN APRVL: P WASON 09/06/2014	
		MFG APRVL: W BENEICT 09/08/2014	
		QA APRVL: C LINDQUIST 09/08/2014	
		MKT APRVL: --	
		PROD FARM: --	
		PROJECT #: --	
		SIZE	
		DRAWING NO	
		WSC83822	
		REV	
		B	
		SHEET 36 OF 50	



REV	DATE	DESCRIPTION	ECO	BY	CHK.
B	07/30/2014	DRAWING RELEASED	37118	RK	MB

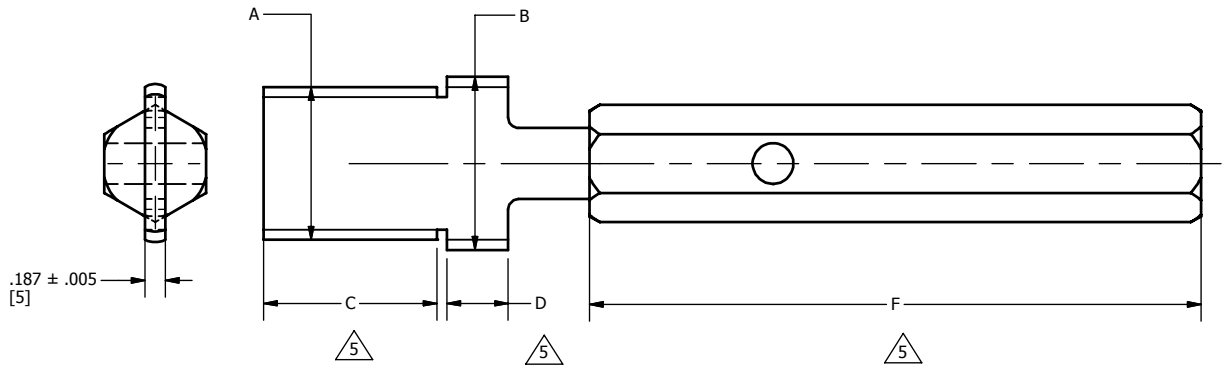

FIG. 3

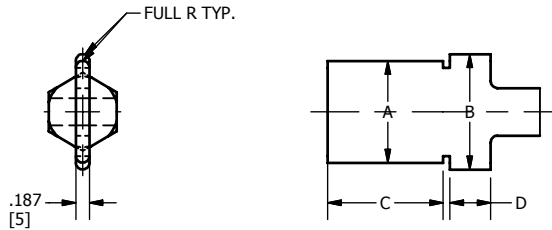
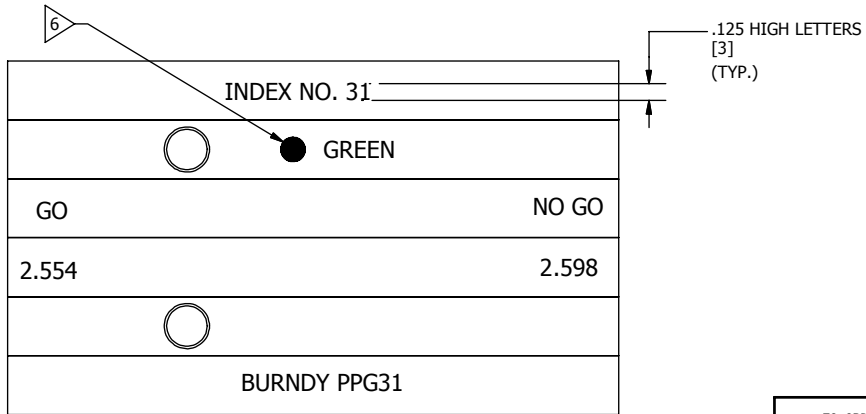

FIG. 4
(USE SAME HANDLE AS FIG. 3)



VIEW OF FIG. 3 HEX HANDLE UNFOLDED

NOTES:

1. DIMENSIONS IN BRACKETS [] ARE IN MILLIMETERS ROUNDED OFF TO THE NEAREST MILLIMETER, UNLESS OTHERWISE SPECIFIED AND ARE FOR REFERENCE ONLY.

6 > .12 DIA. SPOT DRILL, COLOR DOT & WORD TO BE FILLED WITH PAINT STIK IN APPROPRIATE COLOR (SEE TABLE)

TO ORDER BURNDY® PRODUCTS CALL		INSPECTION GAGE	
UNITED STATES 1-800-346-4175 (LONDONDERRY, NH)		ITEM NO: N/A	
CANADA: 1-800-361-6975 (QUEBEC) 1-800-387-6487 (ALL OTHER PROVINCES)		CAT. NO: PPG (TABLE)	
FOR PRODUCT INFO: http://www.burndy.com		DRAWN BY: rkonathala 07/30/2014	
		CHECKER: --	
		DSN APRVL: P WASON 09/06/2014	
		MFG APRVL: W BENEDET 09/08/2014	
		QA APRVL: C LINDQUIST 09/08/2014	
		MKT APRVL: --	
		PROD FARM: --	
		PROJECT #: --	
		DOCUMENT TYPE: SALES	
		REL LEVEL: Released	
		DRAWING NO	
		WSC83822	
		SHEET 37 OF 50	
		REV	
		B	

GAGE CAT. NO.	FIG. NO.	'A'		'B'		DIE SET CAT NO.	DIE SET 'G' DIM.	COLOR DOT PER MUNSSELL COLOR CHART
		GO GAGE		NO GO GAGE				
		SIZE	TOL. \triangleleft 1	SIZE	TOL. \triangleleft 1			
PPG25	4	1.1080 [28.143]	+0.0003 -0.0000	1.1520 [29.261]	+0.0000 -0.0003	P40RT	1.128 [28.65] 1.152 [29.26]	NO REQT.
PPG31	2	1.5540 [39.472]	+0.0003 -0.0000	1.5980 [40.589]	+0.0000 -0.0003	P46RT	1.574 [39.98] 1.598 [40.59]	GREEN 5GY 3/4 - 10GY 3/2
PPG40	---	---	---	---	---	---	---	---
PPG48	---	---	---	---	---	---	---	---

REV	DATE	DESCRIPTION	ECO	BY	CHK.
B	07/30/2014	DRAWING RELEASED	37118	RK	MB

TO ORDER BURNDY® PRODUCTS CALL		INSPECTION GAGE	
UNITED STATES		ITEM NO: N/A	
1-800-346-4175 (LONDONDERRY, NH)		CAT. NO: PPG (TABLE)	
CANADA:		DRAWN BY: rkonathala 07/30/2014	
1-800-361-6975 (QUEBEC)		CHECKER: --	
1-800-387-6487 (ALL OTHER PROVINCES)		DSN APRVL: P WASON 09/06/2014	
FOR PRODUCT INFO: http://www.burndy.com		MFG APRVL: W BENEDET 09/08/2014	
		QA APRVL: C LINDQUIST 09/08/2014	
		MKT APRVL: --	
		PROD FARM: --	
		PROJECT #: --	
		DRAWING NO	
		WSC83822	
		REV	
		B	
		SHEET 38 OF 50	

GAGE CAT. NO.	FIG. NO.	'A'		'B'		DIE SET CAT NO.	DIE SET 'G' DIM.	COLOR DOT PER MUNSSELL COLOR CHART
		GO GAGE		NO GO GAGE				
		SIZE	TOL < 1	SIZE	TOL < 1			
PPG998	4	1.4380 [36.525]	+0.0005 -0.0000	1.4780 [37.541]	+0.0000 -0.0005	P998	1.458 [37.03] 1.478 [37.54]	NO REQT.
PPG999	4	1.1360 [28.854]	+0.0005 -0.0000	1.1920 [30.277]	+0.0000 -0.0005	P999	1.156 [29.36] 1.192 [30.28]	NO REQT.

REV	DATE	DESCRIPTION	ECO	BY	CHK.
B	07/30/2014	DRAWING RELEASED	37118	RK	MB

TO ORDER BURNDY® PRODUCTS CALL		INSPECTION GAGE	
UNITED STATES		ITEM NO: N/A	
1-800-346-4175 (LONDONDERRY, NH)		CAT. NO: PPG (TABLE)	
CANADA:		DRAWN BY: rkonathale 07/30/2014	
1-800-361-6975 (QUEBEC)		CHECKER: --	
1-800-387-6487 (ALL OTHER PROVINCES)		DSN APRVL: P WASON 09/06/2014	
FOR PRODUCT INFO: http://www.burndy.com		MFG APRVL: W BENEDET 09/08/2014	
		QA APRVL: C LINDQUIST 09/08/2014	
		MKT APRVL: --	
		PROD FARM: --	
		PROJECT #: --	
		DOCUMENT TYPE: SALES	
		REL LEVEL: Released	
		DRAWING NO	
		W5C83822	
		SHEET 39 OF 50	
		REV	
		B	

GAGE CAT. NO.	FIG. NO.	'A'		'B'		DIE SET CAT NO.	DIE SET 'G' DIM.	COLOR DOT PER MUNSELL COLOR CHART
		GO GAGE		NO GO GAGE				
		SIZE	TOL. $\triangleleft 1$	SIZE	TOL. $\triangleleft 1$			
PUPG998	4	1.4180 [36.017]	+0.0005 -0.0000	1.4660 [37.236]	+0.0000 -0.0005	PU998	1.438 [36.53] 1.466 [37.24]	NO REQT.

REV	DATE	DESCRIPTION	ECO	BY	CHK.
B	07/30/2014	DRAWING RELEASED	37118	RK	MB

TO ORDER BURNDY® PRODUCTS CALL		INSPECTION GAGE	
UNITED STATES		ITEM NO: N/A	
1-800-346-4175 (LONDONDERRY, NH)		CAT. NO: PPG (TABLE)	
CANADA:		DRAWN BY: rkonathale 07/30/2014	
1-800-361-6975 (QUEBEC)		CHECKER: --	
1-800-387-6487 (ALL OTHER PROVINCES)		DSN APRVL: P WASON 09/06/2014	
FOR PRODUCT INFO: http://www.burndy.com		MFG APRVL: W BENEICT 09/08/2014	
		QA APRVL: C LINDQUIST 09/08/2014	
		MKT APRVL: --	
		PROD FAM: --	
		PROJECT #: --	
		DRAWING NO	
		WCS83822	
		REV	
		B	
		SHEET 40 OF 50	

REV	DATE	DESCRIPTION	ECO	BY	CHK.
B	07/30/2014	DRAWING RELEASED	37118	RK	MB

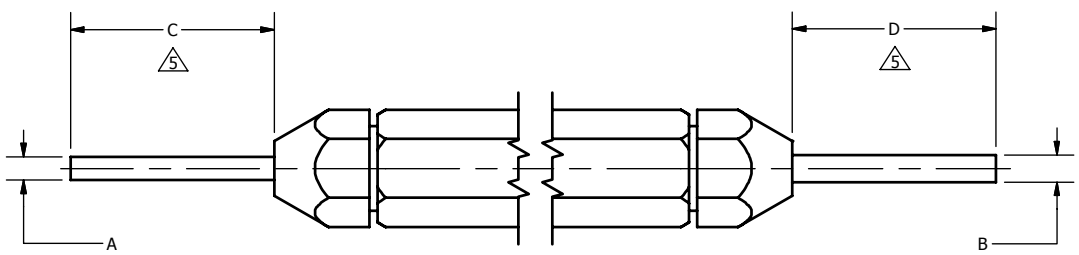

FIG. 1
(WIRE TYPE)

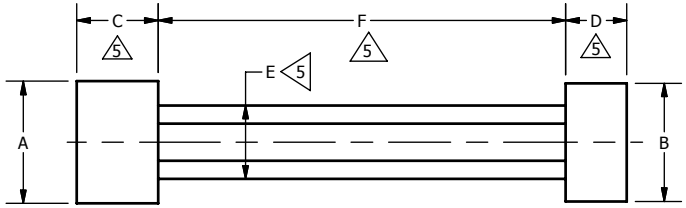
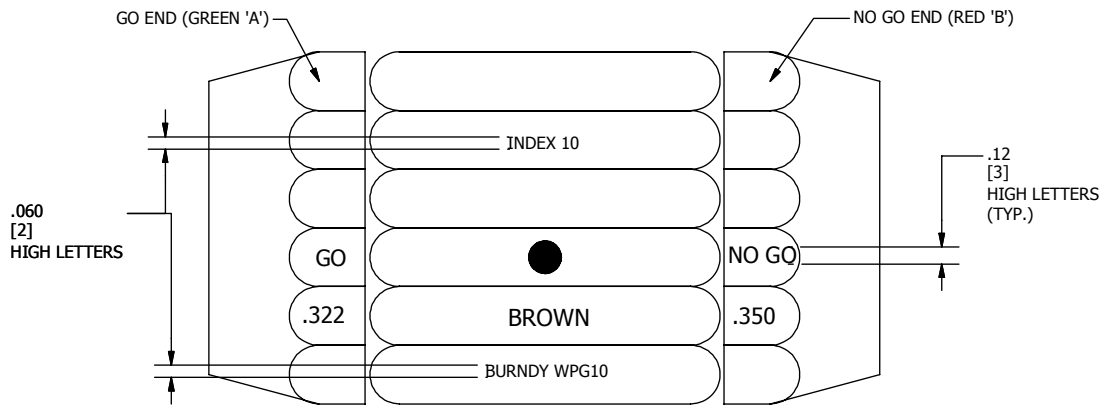
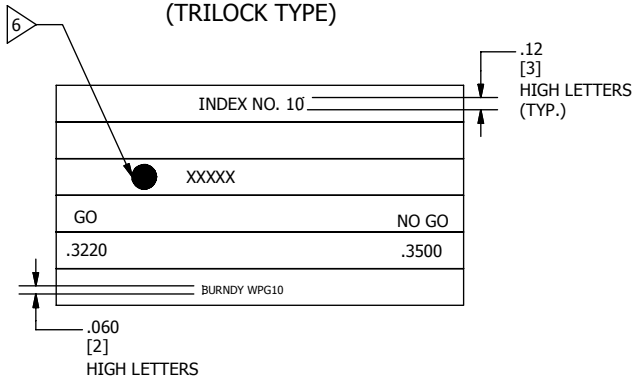

FIG. 2
(TRILOCK TYPE)



VIEW OF FIG. 1 HEX HANDEL UNFOLDED



VIEW OF FIG. 2 HEX HANDEL UNFOLDED

- NOTES :
- 1 TOLERANCE FOR FIG TYPES ARE AS FOLLOES:
 FIG.1 = +.0002 & -.0002
 FIG.2 = +.0003 & -.0003
 FIG.3 = +.0003 & -.0003
 FIG.4 = +.0005 & -.0005

- 4. ALL LETTERING PER BURNDY SPEC. L217 GROUP 1B. LETTERING TO BE FILLED WITH BLACK LACQUER.
- 5 DIMS. C-D-E-F ARE GAGE MFG'S STANDARD, UNLESS OTHERWISE SPECIFIED.
- 6 .12 DIA. SPOT DRILL COLOR DOT & WORD TO BE FILLED WITH PAINT STIK IN IN APPROPRIATE COLOR (SEE TABLE)

TO ORDER BURNDY® PRODUCTS CALL		INSPECTION GAGE	
UNITED STATES 1-800-346-4175 (LONDONDERRY, NH)		ITEM NO: N/A	
CANADA: 1-800-361-6975 (QUEBEC) 1-800-387-6487 (ALL OTHER PROVINCES)		CAT. NO: WPG (TABLE)	
FOR PRODUCT INFO: http://www.burndy.com		DRAWN BY: rkonathale 07/30/2014	
		CHECKER: --	
		DSN APRVL: P WASON 09/06/2014	
		MFG APRVL: W BENEICT 09/08/2014	
		QA APRVL: C LINDQUIST 09/08/2014	
		MKT APRVL: --	
		PROD FAM: --	
		PROJECT #: --	
		DOCUMENT TYPE: SALES	
		REL LEVEL: Released	
		DRAWING NO	
		WSC83822	
		SHEET 41 OF 50	
		REV	
		B	

CUSTOMER NAME	INDEX NO. USED BY CUSTOMER
PHIPPS BEND NUCLEAR FACILITY	WPG7, 8, 10, 12, 13, 15, 16, 17, 19, 20, 49
TVA - HARTSVILLE, TENN	WPG7, 8, 10, 12, 13, 15, 49

REV	DATE	DESCRIPTION	ECO	BY	CHK.
B	07/30/2014	DRAWING RELEASED	37118	RK	MB

NOTES:
THIS SHEET IS FOR BURNDY PERSONEL ONLY.
IT IS NOT TO BE ISSUED TO ANY CUSTOMER.

TO ORDER BURNDY® PRODUCTS CALL		INSPECTION GAGE	
UNITED STATES		ITEM NO: N/A	
1-800-346-4175 (LONDONDERRY, NH)		CAT. NO: WPG (TABLE)	
CANADA:		DRAWN BY: rkonathale 07/30/2014	
1-800-361-6975 (QUEBEC)		CHECKER: --	
1-800-387-6487 (ALL OTHER PROVINCES)		DSN APRVL: P WASON 09/06/2014	
FOR PRODUCT INFO: http://www.burndy.com		MFG APRVL: W BENEDICT 09/08/2014	
		QA APRVL: C LINDQUIST 09/08/2014	
		MKT APRVL: --	
		PROD FIRM: --	
		PROJECT #: --	
		SIZE	
		DOCUMENT TYPE: SALES	
		REL LEVEL: Released	
		DRAWING NO	
		WSC83822	
		REV	
		B	
		SHEET 42 OF 50	



REV	DATE	DESCRIPTION	ECO	BY	CHK.
B	07/30/2014	DRAWING RELEASED	37118	RK	MB

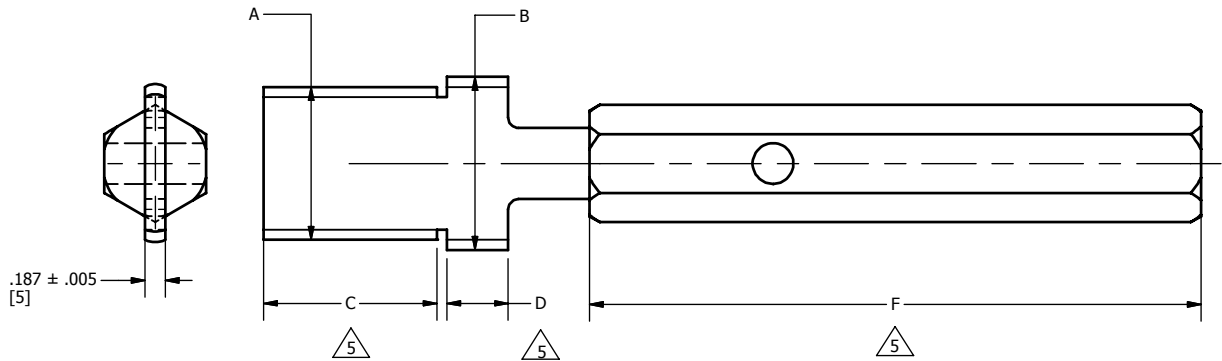

FIG. 3

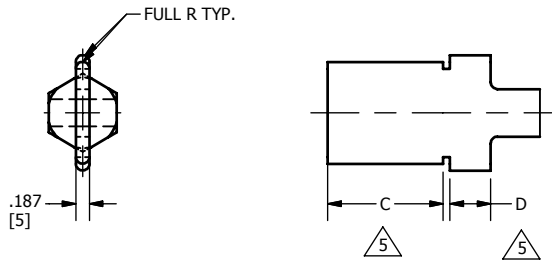
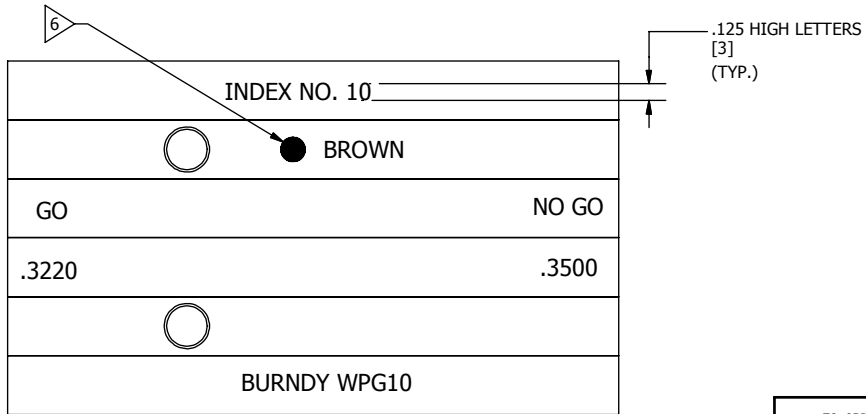

FIG. 4
(USE SAME HANDLE AS FIG. 3)



VIEW OF FIG. 3 HEX HANDLE UNFOLDED

NOTES:

- DIMENSIONS IN BRACKETS [] ARE IN MILLIMETERS ROUNDED OFF TO THE NEAREST MILLIMETER, UNLESS OTHERWISE SPECIFIED AND ARE FOR REFERENCE ONLY.
- 6 >.12 DIA. SPOT DRILL, COLOR DOT & WORD TO BE FILLED WITH PAINT STIK IN APPROPRIATE COLOR (SEE TABLE)

TO ORDER BURNDY® PRODUCTS CALL		INSPECTION GAGE	
UNITED STATES 1-800-346-4175 (LONDONDERRY, NH)		ITEM NO: N/A	CAT. NO: WPG (TABLE)
CANADA: 1-800-361-6975 (QUEBEC) 1-800-387-6487 (ALL OTHER PROVINCES)		DRAWN BY: rkonathala 07/30/2014	CHECKER: --
FOR PRODUCT INFO: http://www.burndy.com		DSN APRVL: P WASON 09/06/2014	MFG APRVL: W BENEICT 09/08/2014
		QA APRVL: C LINDQUIST 09/08/2014	MKT APRVL: --
		PROJ FIRM: --	PROJ #:
		SIZE	DRAWING NO
		REL LEVEL: Released	WSC83822
			SHEET 43 OF 50
			REV
			B

GAGE CAT. NO.	FIG. NO.	'A'		'B'		DIE SET CAT NO.	DIE SET 'G' DIM.	COLOR DOT PER MUNSSELL COLOR CHART
		GO GAGE		NO GO GAGE				
		SIZE	TOL.	SIZE	TOL.			
WPG7	1	.2100 [5.334]	+0.002 -0.000	.2380 [6.045]	+0.000 -0.002	W5CRT	.220 [5.59] .236 [5.99]	BLUE 7.5B MAX. - 1.0
WPG8	1	.2540 [6.452]	+0.002 -0.000	.2820 [7.163]	+0.000 -0.002	W4CRT	.264 [6.71] .280 [7.11]	GRAY N6.0/0 - 5.0/0
WPG10	1	.3220 [8.179]	+0.002 -0.000	.3500 [8.89]	+0.000 -0.002	W2CRT	.332 [8.43] .348 [8.84]	BROWN 5YR 4/10 - 5YR 3/6
WPG12	1	.3960 [10.058]	+0.002 -0.000	.4240 [10.77]	+0.000 -0.002	W25RT	.406 [10.31] .422 [10.72]	PINK 5RP 6/6 - 5RP 6/10
WPG13	1	.4300 [10.922]	+0.002 -0.000	.4620 [11.735]	+0.000 -0.002	W26RT	.444 [11.28] .460 [11.68]	BLACK #5
WPG15	1	.4880 [12.395]	+0.002 -0.000	.5080 [12.903]	+0.000 -0.002	W28RT	.490 [12.45] .506 [12.85]	PURPLE 7.5P 5/10 - 7.5P 4/6
WPG16	1	.5820 [14.783]	+0.002 -0.000	.6040 [15.342]	+0.000 -0.002	W29RT	.586 [14.88] .602 [15.29]	YELLOW 6.25Y 8/12 - 5Y 8/14
WPG17	1	.6420 [16.307]	+0.002 -0.000	.6720 [17.069]	+0.000 -0.002	W30RT	.654 [16.61] .670 [17.02]	WHITE N9.5
WPG19	2	.7440 [18.898]	+0.003 -0.000	.7720 [19.609]	+0.000 -0.003	W32RT	.754 [19.15] .770 [19.56]	BLUE 7.5B MAX. - 1.0
WPG20	2	.7940 [20.168]	+0.003 -0.000	.8140 [20.676]	+0.000 -0.003	W34RT	.796 [20.22] .812 [20.62]	BROWN 5YR 4/10 - 5YR 3/6
WPG49	1	.1700 [4.318]	+0.002 -0.000	.1980 [5.029]	+0.000 -0.002	W8CRT	.180 [4.57] .196 [4.98]	RED 7.5R MAX. - 7.5R 4/12
WPGBG	1	.5320 [13.513]	+0.002 -0.000	.5560 [14.122]	+0.000 -0.002	WBG	.542 [13.77] .554 [14.07]	NONE
WPGD3	4	1.2180 [30.937]	+0.003 -0.000	1.2460 [31.648]	+0.000 -0.003	WD3	1.228 [31.19] 1.244 [31.60]	NONE

REV	DATE	DESCRIPTION	ECO	BY	CHK.
B	07/30/2014	DRAWING RELEASED	37118	RK	MB

TO ORDER BURNDY® PRODUCTS CALL		INSPECTION GAGE	
UNITED STATES 1-800-346-4175 (LONDONDERRY, NH)		ITEM NO: N/A	
CANADA: 1-800-361-6975 (QUEBEC)		CAT. NO: SPG (TABLE)	
1-800-387-6487 (ALL OTHER PROVINCES)		DRAWN BY: rkonathala 07/30/2014	
FOR PRODUCT INFO: http://www.burndy.com		CHECKER: --	
		DSN APRVL: P WASON 09/06/2014	
		MFG APRVL: W BENEDET 09/08/2014	
		QA APRVL: C LINDQUIST 09/08/2014	
		MKT APRVL: --	
		PROD FARM: --	
		PROJECT #: --	
		DRAWING NO	
		WCS83822	
		SHEET 44 OF 50	
		REV	
		B	

REV	DATE	DESCRIPTION	ECO	BY	CHK.
B	07/30/2014	DRAWING RELEASED	37118	RK	MB

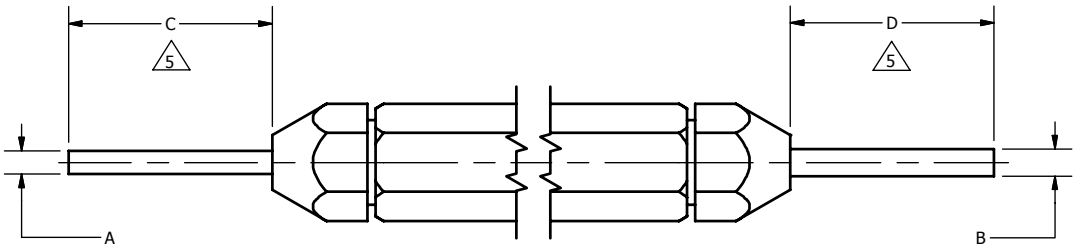

FIG. 1
(WIRE TYPE)

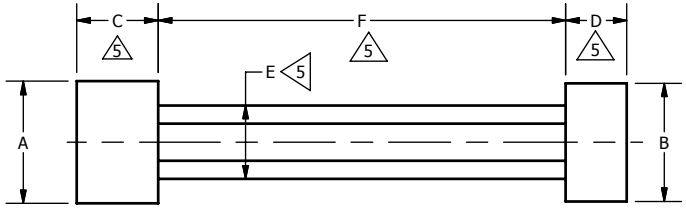
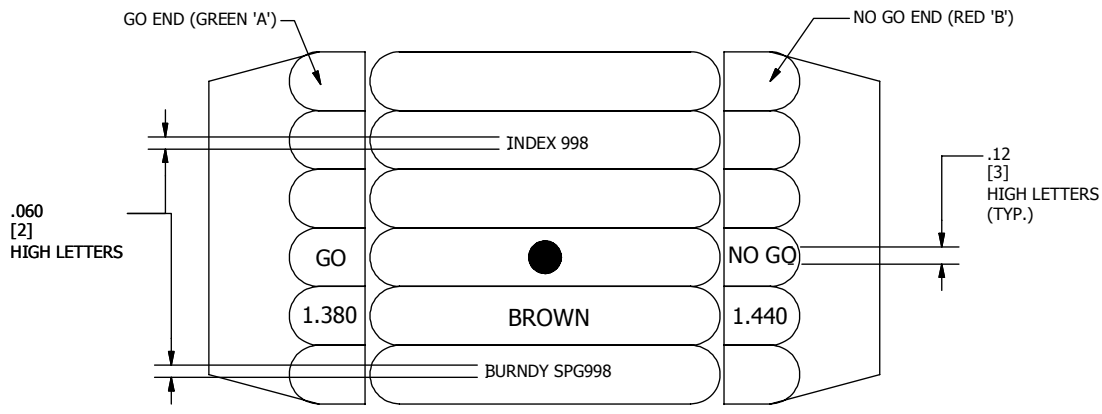
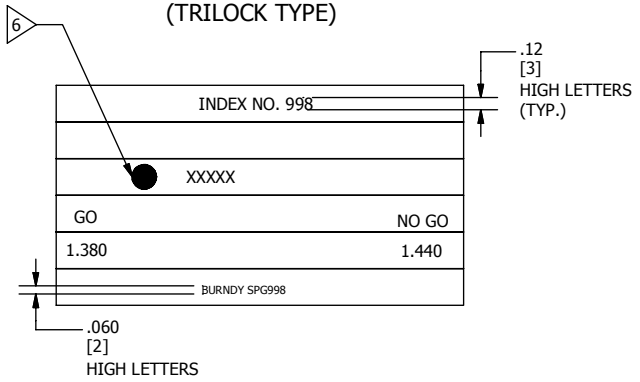

FIG. 2
(TRILOCK TYPE)



VIEW OF FIG. 1 HEX HANDEL UNFOLDED



VIEW OF FIG. 2 HEX HANDEL UNFOLDED

- NOTES :
- 1 TOLERANCE FOR FIG TYPES ARE AS FOLLOES:
 FIG.1 = +.0002 & -.0002
 FIG.2 = +.0003 & -.0003
 FIG.3 = +.0003 & -.0003
 FIG.4 = +.0005 & -.0005

- 4. ALL LETTERING PER BURNDY SPEC. L217 GROUP 1B. LETTERING TO BE FILLED WITH BLACK LACQUER.
- 5 DIMS. C-D-E-F ARE GAGE MFG'S STANDARD, UNLESS OTHERWISE SPECIFIED.
- 6 .12 DIA. SPOT DRILL COLOR DOT & WORD TO BE FILLED WITH PAINT STIK IN IN APPROPRIATE COLOR (SEE TABLE)

TO ORDER BURNDY® PRODUCTS CALL		INSPECTION GAGE	
UNITED STATES 1-800-346-4175 (LONDONDERRY, NH)		ITEM NO: N/A	
CANADA: 1-800-361-6975 (QUEBEC) 1-800-387-6487 (ALL OTHER PROVINCES)		CAT. NO: SPG (TABLE)	
FOR PRODUCT INFO: http://www.burndy.com		DRAWN BY: rkonathala 07/30/2014	
		CHECKER: --	
		DSN APRVL: P WASON 09/06/2014	
		MFG APRVL: W BENEICT 09/08/2014	
		QA APRVL: C LINDQUIST 09/08/2014	
		MKT APRVL: --	
		PROD FAM: --	
		PROJECT #: --	
		DOCUMENT TYPE: SALES	
		REL LEVEL: Released	
		DRAWING NO	
		W5C83822	
		SHEET 45 OF 50	
		REV	
		B	

CUSTOMER NAME	INDEX NO. USED BY CUSTOMER
PHIPPS BEND NUCLEAR FACILITY	SPG998, 999
DUKE POWER FACILITY	SPG 24, 27
LIMERICK - BECHTEL	SPG27

REV	DATE	DESCRIPTION	ECO	BY	CHK.
B	07/30/2014	DRAWING RELEASED	37118	RK	MB

NOTES:
THIS SHEET IS FOR BURNDY PERSONEL ONLY.
IT IS NOT TO BE ISSUED TO ANY CUSTOMER.

TO ORDER BURNDY® PRODUCTS CALL UNITED STATES 1-800-346-4175 (LONDONDERRY, NH) CANADA: 1-800-361-6975 (QUEBEC) 1-800-387-6487 (ALL OTHER PROVINCES) FOR PRODUCT INFO: http://www.burndy.com	CUSTOMER REFERENCE LIST		
	ITEM NO: N/A		
	CAT. NO: SPG (TABLE)		
	DRAWN BY: rkonathale	07/30/2014	
	CHECKER: --		
	DSN APRVL: P WASON	09/06/2014	
	MFG APRVL: W BENEDICT	09/08/2014	
	QA APRVL: C LINDQUIST	09/08/2014	
	MKT APRVL: --		
	PROD FIRM: --		
PROJECT #: --			
DOCUMENT TYPE: SALES	SIZE	DRAWING NO	REV
REL LEVEL: Released	B	WSC83822	B
		SHEET 46 OF 50	



REV	DATE	DESCRIPTION	ECO	BY	CHK.
B	07/30/2014	DRAWING RELEASED	37118	RK	MB

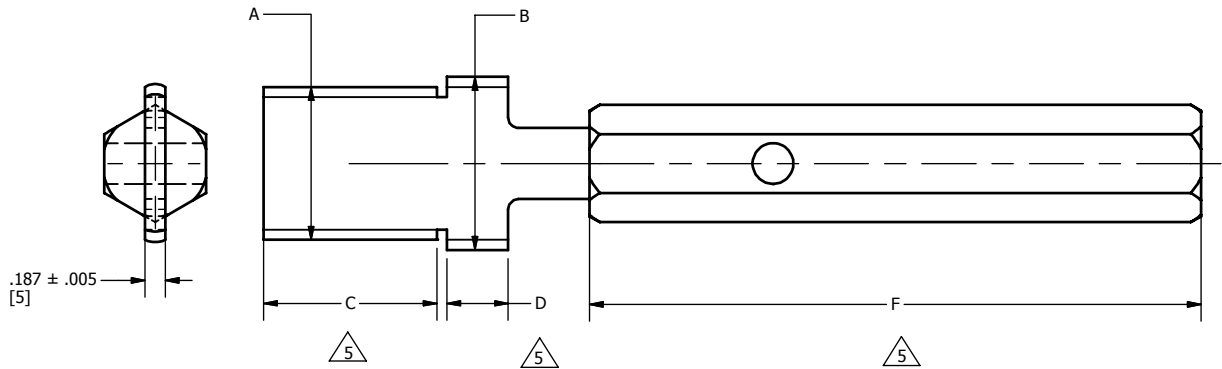

FIG. 3

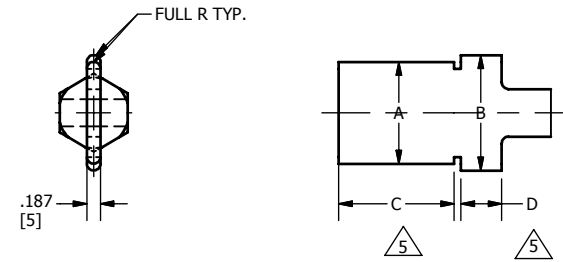
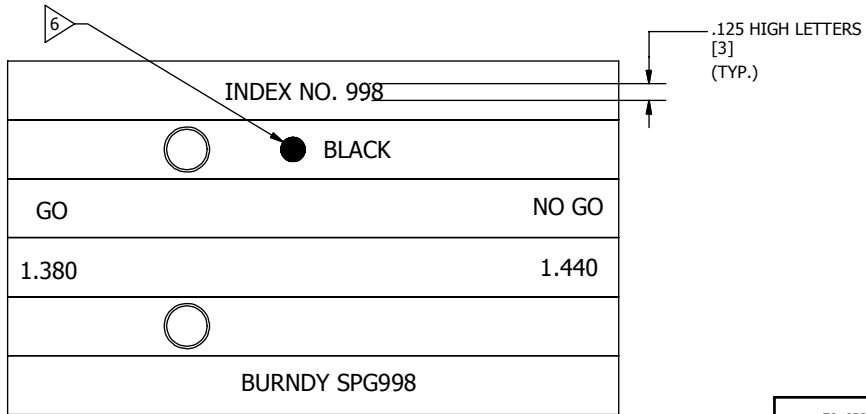

FIG. 4



VIEW OF HEX HANDLE UNFOLDED TYP. FOR FIG 3&4

NOTES:

1. DIMENSIONS IN BRACKETS [] ARE IN MILLIMETERS ROUNDED OFF TO THE NEAREST MILLIMETER, UNLESS OTHERWISE SPECIFIED AND ARE FOR REFERENCE ONLY.

6 > .12 DIA. SPOT DRILL, COLOR DOT & WORD TO BE FILLED WITH PAINT STIK IN APPROPRIATE COLOR (SEE TABLE)

TO ORDER BURNDY® PRODUCTS CALL		INSPECTION GAGE	
UNITED STATES 1-800-346-4175 (LONDONDERRY, NH)		ITEM NO: N/A	CAT. NO: SPG (TABLE)
CANADA: 1-800-361-6975 (QUEBEC) 1-800-387-6487 (ALL OTHER PROVINCES)		DRAWN BY: rkonathale 07/30/2014	CHECKER: --
FOR PRODUCT INFO: http://www.burndy.com		DSN APRVL: P WASON 09/06/2014	MFG APRVL: W BENEICT 09/08/2014
		QA APRVL: C LINDQUIST 09/08/2014	MKT APRVL: --
		PROD FARM: --	PROJECT #: --
		DOCUMENT TYPE: SALES	REL LEVEL: Released
		SIZE: B	DRAWING NO: WSC83822
			REV: B
			SHEET 47 OF 50



GAGE CAT. NO.	FIG. NO.	'A'		'B'		DIE SET CAT NO.	DIE SET 'G' DIM.	COLOR DOT PER MUNSSELL COLOR CHART
		GO GAGE		NO GO GAGE				
		SIZE	TOL. <1	SIZE	TOL. <1			
SPG20	---	---	---	---	---	---	---	---
SPG24	1	1.0010 [25.425]	+0.0002 -0.0000	1.0810 [27.457]	+0.0000 -0.0002	S39RT	1.021 [25.93] 1.081 [27.46]	NO REQ.
SPG25	---	---	---	---	---	---	---	---
SPG27	2	1.1850 [30.099]	+0.0002 -0.0000	1.2650 [32.131]	+0.0000 -0.0002	S44RT	1.205 [30.61] 1.265 [32.13]	NO REQ.
SPG30	---	---	---	---	---	---	---	---
SPG35	---	---	---	---	---	---	---	---
SPG40	---	---	---	---	---	---	---	---
SPG43	---	---	---	---	---	---	---	---

REV	DATE	DESCRIPTION	ECO	BY	CHK.
B	07/30/2014	DRAWING RELEASED	37118	RK	MB

TO ORDER BURNDY® PRODUCTS CALL		INSPECTION GAGE	
UNITED STATES		ITEM NO: N/A	
1-800-346-4175 (LONDONDERRY, NH)		CAT. NO: SPG (TABLE)	
CANADA:		DRAWN BY: rkonathala 07/30/2014	
1-800-361-6975 (QUEBEC)		CHECKER: --	
1-800-387-6487 (ALL OTHER PROVINCES)		DSN APRVL: P WASON 09/06/2014	
FOR PRODUCT INFO: http://www.burndy.com		MFG APRVL: W BENEICT 09/08/2014	
		QA APRVL: C LINDQUIST 09/08/2014	
		MKT APRVL: --	
		PROD FARM: --	
		PROJECT #: --	
		DOCUMENT TYPE: SALES	
		REL LEVEL: Released	
		DRAWING NO	
		WSC83822	
		SHEET 48 OF 50	
		REV	
		B	

GAGE CAT. NO.	FIG. NO.	'A'		'B'		DIE SET CAT NO.	DIE SET 'G' DIM.	COLOR DOT PER MUNSELL COLOR CHART
		GO GAGE		NO GO GAGE				
		SIZE	TOL. <1	SIZE	TOL. <1			
SPG293	---	---	---	---	---	---	---	---
SPG301	2	1.2290 [31.217]	+0.0002 -0.0000	1.3090 [33.249]	+0.0000 -0.0002	S39ART	1.249 [31.72] 1.309 [33.25]	RED 7.5R MAX. - 7.5R 4/12
SPG306	---	---	---	---	---	---	---	---

REV	DATE	DESCRIPTION	ECO	BY	C'HK.
B	07/30/2014	DRAWING RELEASED	37118	RK	MB

TO ORDER BURNDY® PRODUCTS CALL		INSPECTION GAGE	
UNITED STATES		ITEM NO: N/A	
1-800-346-4175 (LONDONDERRY, NH)		CAT. NO: SPG (TABLE)	
CANADA:		DRAWN BY: rkonathale 07/30/2014	
1-800-361-6975 (QUEBEC)		CHECKER: --	
1-800-387-6487 (ALL OTHER PROVINCES)		DSN APRVL: P WASON 09/06/2014	
FOR PRODUCT INFO: http://www.burndy.com		MFG APRVL: W BENEDET 09/08/2014	
		QA APRVL: C LINDQUIST 09/08/2014	
		MKT APRVL: --	
		PROJ. FIRM: --	
		PROJECT #: --	
		DOCUMENT TYPE: SALES	
		REL LEVEL: Released	
		DRAWING NO	
		WSC83822	
		SHEET 49 OF 50	
		REV	
		B	

GAGE CAT. NO.	FIG. NO.	'A'		'B'		DIE SET CAT NO.	DIE SET 'G' DIM.	COLOR DOT PER MUNSSELL COLOR CHART
		GO GAGE		NO GO GAGE				
		SIZE	TOL <1	SIZE	TOL <1			
SPG985	---	---	---	---	---	---	---	---
SPG998	4	1.3800 [35.052]	+0.0005 -0.0000	1.4400 [36.576]	+0.0000 -0.0005	S998	1.400 [35.56] 1.440 [36.58]	NO REQ.
SPG999	4	1.8640 [47.345]	+0.0005 -0.0000	1.9240 [48.869]	+0.0000 -0.0005	S999	1.884 [47.85] 1.924 [48.87]	NO REQ.
SPG1008	---	---	---	---	---	---	---	---

REV	DATE	DESCRIPTION	ECO	BY	CHK.
B	07/30/2014	DRAWING RELEASED	37118	RK	MB

TO ORDER BURNDY® PRODUCTS CALL		INSPECTION GAGE	
UNITED STATES		ITEM NO: N/A	
1-800-346-4175 (LONDONDERRY, NH)		CAT. NO: SPG (TABLE)	
CANADA:		DRAWN BY: rkonathala 07/30/2014	
1-800-361-6975 (QUEBEC)		CHECKER: --	
1-800-387-6487 (ALL OTHER PROVINCES)		DSN APRVL: P WASON 09/06/2014	
FOR PRODUCT INFO: http://www.burndy.com		MFG APRVL: W BENEICT 09/08/2014	
		QA APRVL: C LINDQUIST 09/08/2014	
		MKT APRVL: --	
		PROD FARM: --	
		PROJECT #: --	
		DOCUMENT TYPE: SALES	
		REL LEVEL: Released	
		DRAWING NO	
		WSC83822	
		SHEET 50 OF 50	
		REV	
		B	