

CATALOG NUMBER	NOMINAL SIZE	THREADS PER INCH <span style="border: 1px solid black; padding: 2px;">2</span>	E BODY DIA.	F ACROSS FLATS	G ACROSS CORNERS	H HEAD HEIGHT	L BOLT LENGTH <span style="border: 1px solid black; padding: 2px;">4</span>
25X31HEB	1/4 (.250)	20	.250 MAX.	.438 .425	.505 .484	.188 .150	.31
25X44HEB							.44
25X50HEB							.50
25X62HEB							.62
25X75HEB							.75
25X100HEB							1.00
25X125HEB							1.25
25X150HEB							1.50
25X200HEB							2.00
25X250HEB							2.50
25X300HEB							3.00
25X350HEB							3.50

REV	DATE	DESCRIPTION	ECO	BY	C'H'K.
A	05/24/2013	COMBINE SHEET AS PER MARKUP	31798	PM	MB

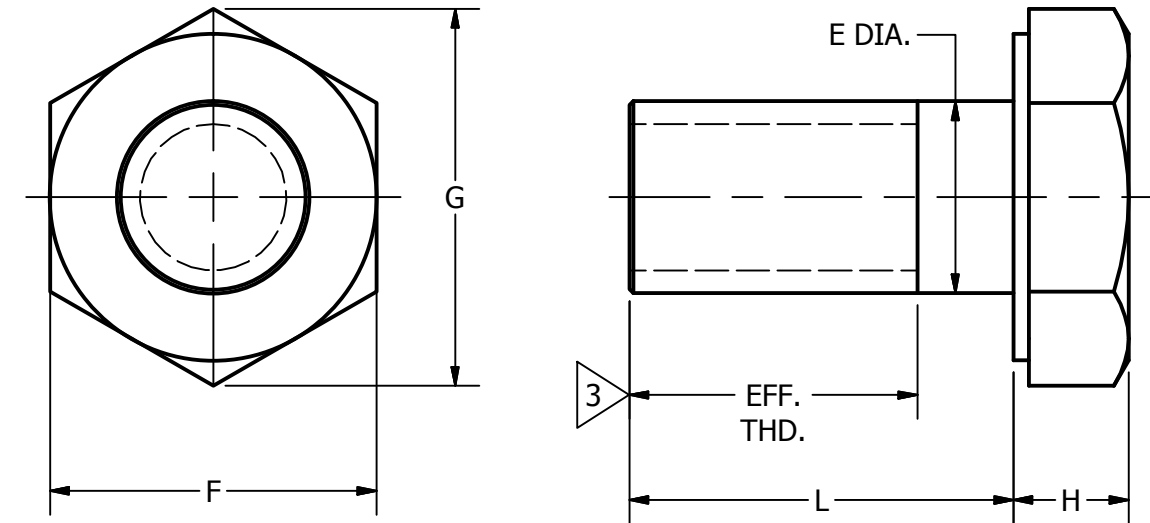



<span style="border: 1px solid black; padding: 2px;">4</span> BOLT LENGTH TOLERANCES	
NOMINAL LENGH	NOMINAL SIZE
UP TO 1 IN., INCL.	+02 -03
OVER 1 IN. TO 2 1/2 IN., INCL.	+02 -04
OVER 2 1/2 IN. TO 4 IN., INCL.	+04 -06
OVER 4 IN. TO 6 IN., INCL.	+06 -10
LONGER THAN 6 IN.	+12 -18

**NOTES:**

1. MATERIAL : SILICON BRONZE.
- 2 ALL THREADS ARE OF THE UNIFIED NATIONAL COARSE THREAD SERIES - CLASS 2A.
- 3 ALL HEX. HEAD BOLTS UP TO AND INCLUDING 2" IN LENGTH SHALL BE FULLY THREADED. ALL HEX. HEAD BOLTS OVER 2" IN LENGTH SHALL HAVE A MINIMUM EFFECTIVE THREAD OF 2".
- 4 SEE TABLE FOR BOLT LENGTH TOLERANCES.

REFERENCE : H108, DA084327

TO ORDER BURNDY® PRODUCTS CALL		<b>BOLT, SILICON BRONZE</b>	
UNITED STATES 1-800-346-4175 (LONDONDERRY, NH)		ITEM NO: N/A	
CANADA: 1-800-361-6975 (QUEBEC) 1-800-387-6487 (ALL OTHER PROVINCES)		CAT. NO: SEE TABLE	
FOR PRODUCT INFO: <a href="http://www.burndy.com">http://www.burndy.com</a>		DRAWN BY: JEL 11/30/1990	
		CHECKER: KLH 12/07/1990	
		DSN APRVL: MAL 12/11/1990	
		MFG APRVL: --	
		QA APRVL: A.L. 12/11/1990	
		MKT APRVL: --	
		PROD FAM: --	
		DRAWING NO	
		WSD206493	
		REV	
		A	
		SHEET 1 OF 3	



CATALOG NUMBER	NOMINAL SIZE	THREADS PER INCH 	E BODY DIA.	F ACROSS FLATS	G ACROSS CORNERS	H HEAD HEIGHT	L BOLT LENGTH 
38X31HEB	3/8 (.375)	16	.375 MAX.	.562 .544	.650 .620	.268 .226	.31
38X44HEB							.44
38X50HEB							.50
38X62HEB							.62
38X75HEB							.75
38X88HEB							.88
38X100HEB							1.00
38X112HEB							1.12
38X125HEB							1.25
38X150HEB							1.50
38X175HEB							1.75
38X200HEB							2.00
38X225HEB							2.25
38X250HEB							2.50
38X275HEB							2.75
38X300HEB							3.00
38X325HEB							3.25
38X350HEB							3.50
38X400HEB							4.00
38X450HEB							4.50
38X500HEB	5.00						

REV	DATE	DESCRIPTION	ECO	BY	C'H'K.
A	05/24/2013	COMBINE SHEET AS PER MARKUP	31798	PM	MB

REFER SHEET #1 FOR NOTES AND BOLT LENGTH TOLERANCES.

REFERENCE : H108, DA084327

TO ORDER BURNDY® PRODUCTS CALL		BOLT, SILICON BRONZE	
UNITED STATES 1-800-346-4175 (LONDONDERRY, NH)		ITEM NO: N/A	
CANADA: 1-800-361-6975 (QUEBEC) 1-800-387-6487 (ALL OTHER PROVINCES)		CAT. NO: SEE TABLE	
FOR PRODUCT INFO: <a href="http://www.burndy.com">http://www.burndy.com</a>		DRAWN BY: JEL 11/30/1990	
	CHECKER: KLH 12/07/1990	DSN APRVL: MAL 12/11/1990	
	MFG APRVL: --	QA APRVL: A.L. 12/11/1990	
	MKT APRVL: --	PROD FAM: --	
		PROJECT #: --	
		DOCUMENT TYPE: SALES	DRAWING NO: WSD206493
		REL LEVEL: Released	SIZE: B
			SHEET 2 OF 3
			REV: A

CATALOG NUMBER	NOMINAL SIZE	THREADS PER INCH 	E BODY DIA.	F ACROSS FLATS	G ACROSS CORNERS	H HEAD HEIGHT	L BOLT LENGTH 
50X31HEB	1/2 (.500)	13	.500 MAX.	.750 .725	.866 .826	.364 .302	.31
50X44HEB							.44
50X62HEB							.62
50X75HEB							.75
50X100HEB							1.00
50X125HEB							1.25
50X150HEB							1.50
50X175HEB							1.75
50X200HEB							2.00
50X225HEB							2.25
50X250HEB							2.50
50X275HEB							2.75
50X300HEB							3.00
50X325HEB							3.25
50X350HEB							3.50
50X375HEB							3.75
50X400HEB							4.00
50X450HEB							4.50
50X500HEB							5.00
50X550HEB							5.50
50X600HEB	6.00						
50X700HEB	7.00						
50X750HEB	7.50						

REV	DATE	DESCRIPTION	ECO	BY	C'H'K.
A	05/24/2013	COMBINE SHEET AS PER MARKUP	31798	PM	MB

REFERENCE : H108, DA084327

REFER SHEET #1 FOR NOTES AND BOLT LENGTH TOLERANCES.

TO ORDER BURNDY® PRODUCTS CALL		BOLT, SILICON BRONZE	
UNITED STATES 1-800-346-4175 (LONDONDERRY, NH)		ITEM NO: N/A	
CANADA: 1-800-361-6975 (QUEBEC) 1-800-387-6487 (ALL OTHER PROVINCES)		CAT. NO: SEE TABLE	
FOR PRODUCT INFO: <a href="http://www.burndy.com">http://www.burndy.com</a>		DRAWN BY: JEL 11/30/1990	
	CHECKER: KLH 12/07/1990	DSN APRVL: MAL 12/11/1990	
	MFG APRVL: --	QA APRVL: A.L. 12/11/1990	
	MKT APRVL: --	PROD FAM: --	
		PROJ #: --	
		DOCUMENT TYPE: SALES	DRAWING NO: WSD206493
		REL LEVEL: Released	SIZE: B
			SHEET 3 OF 3
			REV: A