

# 6L-R-D

MOD™ 6 LED RECESSED DIRECT

## FEATURES

- Variable Intensity technology provides a range of specifiable outputs and resulting fixture wattages
- 2 SDCM color consistency
- End cap design eliminates visible diffuser seams/gaps



## CONTROLS



## SPECIFICATIONS

### CONSTRUCTION

- Housing constructed from die-formed and welded steel with wiring knockouts in top
- End caps constructed from die-formed steel. Installs from below via magnetic interface
- End caps overlap diffuser at each fixture end to eliminate gaps and LED visibility

### OPTICAL PERFORMANCE

- 2 SDCM color consistency, 80 or 90 CRI
- SOF: Soft diffuse acrylic lens
- REG: ½" regressed softglo lens with painted steel inserts. Output multiplier (.77)
- BWO: White blade baffle with softglo lens overlay. Output multiplier (.70)
- BAT: "Batwing" distribution created created from highly transmissive diffuse acrylic lens with linear prisms

### INSTALLATION

- PT Mounting: Continuous spackle trim with beaded edge welded to housing. Spackle trim allows plaster coat up to fixture edge for clean ceiling appearance
- LG/NG/SS Mounting: Side rails provide continuous mounting, lateral spacing between T-bars and allows clearance for T-bar supporting wire. For Tegular grid mount, fixture will sit level with the T-bar
- DW Mounting: Side rails allow installation into drywall slot. Visible flange is located on all 4 sides of fixture

### INSTALLATION (CONTINUED)

- Illuminated corners available in 90°, 120°, 135°. One piece construction, ready to install, with diffusers that match adjoining fixtures. Corner system connectors must be used to form patterns. The length of each outside or inside illuminated corner is 12"
- Fixture weight: 3lbs/ft

### ELECTRICAL

- Variable Intensity (VI) technology allows precise specification of fixture output/wattage. Fixture will be programmed and labeled to specification. Indirect and direct hemispheres can be independently specified
- LED boards and drivers can be accessed and removed from fixture, while installed
- Entire LED module can be removed and replaced
- 1C (1 Circuit) Fixture wired for a single circuit
- Emergency Battery: 10W battery powered driver. Provides a minimum of 90 minutes of emergency lighting. Inverter-Compatible. Provided by others. Available in 4'+ fixtures

### CONTROLS

- Sensors install between diffusers
- NX Distributed Intelligence™: Supports indoor and outdoor applications, wired, wireless and hybrid networked NX lighting control deployments and enabled emerging applications, such as Hubbell Lighting's SpectraSync™ Color Tuning Technology
- SpectraSync™ Color Tuning Technology: Control your space based on the needs of the application, specific activities throughout the day and preferences of the occupants

## MOD<sup>x</sup>

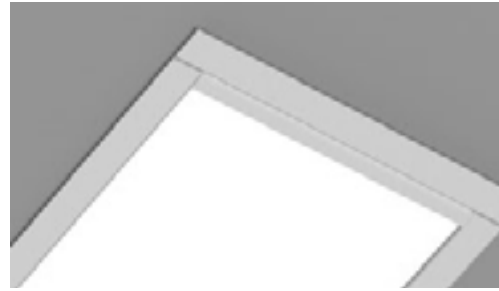

### RELATED PRODUCTS

- Ø [2L-R-D](#) Ø [3L-R-D](#) Ø [4L-R-D](#)

### SERVICE PROGRAMS



### CERTIFICATIONS

- DLC® (DesignLights Consortium) Qualified - see [www.designlights.org](http://www.designlights.org)
- CSA listed for damp location
- IBEW
- AF of L
- UL924
- This product qualifies as a "designated country construction material" per FAR 52.225-11 Buy American-Construction. Materials under Trade Agreements effective 8/14/2020. See [Buy American Solutions](http://Buy American Solutions). Contact factory for configurations including SpectraSync, NX, or sensors.

### WARRANTY

- LED boards - 5 years
- LED drivers (standard) - 5 years
- LED drivers (Lutron) - 3 years
- See [www.litecontrol.com](http://www.litecontrol.com) for details

KEY DATA	
Lumen Range Per Foot	D: 300–1100
Wattage Range Per Foot	2.6–10.0
Efficacy Range (LPW)	110–118
Rated Life (Hours)	L70: >61,000 L90: >61,000

# 6L-R-D

MOD™ 6 LED RECESSED DIRECT

[ ] = Service Program



Click icon for a list of Quick-Ship options

## ORDERING GUIDE

Example: 6L-DW-D-8-3-08-SOF-C1-27K-D030-D01-1C-UNV

CATALOG # [ ]

6L	Ceiling Type <sup>1</sup>	Fixture Distribution	Row Length (In Feet)	Row Length Adder <sup>2</sup>	Max Length in Row	Direct Optical Distribution
6L MOD	<b>DW</b> Drywall <b>PT</b> Drywall with plaster trim (trimless finish) <b>LG</b> 15/16 Grid <b>NG</b> 9/16 Grid <b>SS</b> 9/16 Screw Slot	<b>D</b> Direct	— <sup>1</sup> Enter in foot increments	<b>.3</b> Row length +3" <b>.6</b> Row length +6" <b>.9</b> Row length +9" Measured in inches	<b>02</b> 2', 609 mm <b>03</b> 3', 914 mm <b>04</b> 4', 1219 mm <b>05</b> 5', 1524 mm <b>06</b> 6', 1829 mm <b>08</b> 8', 2438 mm	<b>SOF</b> Soft Diffuse Lens, Lambertian <b>REG</b> Regressed Diffuse Lens <sup>3</sup> <b>BWO</b> Blade Baffle with Overlay <sup>3</sup> <b>BAT</b> Batwing Lens

Finish/Color <sup>4</sup>	Color Temperature	Direct Output/ft <sup>7</sup>	Driver	Circuiting	Voltage
<b>C1</b> Matte White (Default)	<b>27K</b> 2700K <sup>5</sup>	<b>D030</b> 300 (min) <sup>8</sup>	<b>D01</b> 1% Dimming, 0-10V	<b>1C</b> 1 Circuit	<b>UNV</b> Universal Voltage (120V through 277V)
<b>C2</b> Textured Matte White	<b>30K</b> 3000K	to	<b>D00</b> 1% Dim-to-Off, 0-10V		<b>347</b> 347 Volt <sup>5,10</sup>
<b>C3</b> Light Silver	<b>35K</b> 3500K	<b>D125</b> 1250 (max)	<b>D05</b> SpectraSync 5% Dimming, 0-10V <sup>9</sup>		
<b>C4</b> Machined Aluminum	<b>40K</b> 4000K		<b>DS1</b> 1% Dimming w/ Soft Start, 0-10V		
<b>C5</b> Carbon Black	<b>50K</b> 5000K <sup>5</sup>		<b>DS0</b> 1% Dim-to-Off w/ Soft Start, 0-10V		
<b>C6</b> Textured Camera Black	<b>27K9</b> 2700K, 90 CRI <sup>5</sup>		<b>LEC</b> Hi-lume 1% Ecosystem LED Driver		
<b>CC</b> Custom Color	<b>30K9</b> 3000K, 90 CRI		<b>DALI</b> DALI <sup>5</sup>		
	<b>35K9</b> 3500K, 90 CRI		<b>DALIP</b> Powered by DALI (2.0) <sup>5</sup>		
	<b>40K9</b> 4000K, 90 CRI		<b>NDM</b> Non-Dimming		
	<b>50K9</b> 5000K, 90 CRI <sup>5</sup>				
	<b>2230TD</b> 2200K-3000K SpectraSync™ Dim-to-Warm <sup>6</sup>				
	<b>2750T</b> 2700K-5000K SpectraSync™ Tunable White <sup>6</sup>				
	<b>2765T</b> 2700K-6500K SpectraSync™ Tunable White <sup>6</sup>				

## OPTIONAL

Nightlight	Emergency	Thru-wiring	Patterns <sup>5,13</sup>	Chicago Environmental Air Modification
<b>NL</b> Nightlight Circuit Required. Enter quantity. 2NL = 2 nightlight circuits/row	<b>EF</b> 10W Emergency Battery Pack. Enter quantity. 2EF = 2 emergency batteries/row. <sup>11</sup>	<b>W1</b> No Thru Wire <b>W2</b> Provide Normal and Emergency/ Nightlight Thru Wiring <sup>12</sup> <b>W3</b> Provide Normal Thru Wiring Only	<b>C90L</b> Illuminated 90° Corner <b>C120L</b> Illuminated 120° Corner <b>C135L</b> Illuminated 135° Corner	<b>CCEA</b> Chicago Environmental Air Modification

## Control Options<sup>5</sup>

- NX Standalone**  
**NXS** NX, PIR BT Occupancy/Daylight Sensor, Slide Mount<sup>14, 15, 16</sup>
- NX Networked – Wired**  
**NXE** NX, Dual SmartPORTs<sup>14, 15</sup>  
**NXES** NX, PIR BT Occupancy/Daylight Sensor, Slide Mount, Dual SmartPORTs<sup>14, 15</sup>
- NX Networked – Wireless**  
**NXSW** NX Wireless, PIR BT Occupancy/Daylight Sensor<sup>14, 15, 16</sup>  
**NXWE** NX Wireless Enabled<sup>14, 15</sup>
- NX Networked – Wired/Wireless**  
**NXSWD** NX Wireless, PIR BT Occupancy/Daylight Sensor, Dual SmartPORTs<sup>14, 15, 16</sup>  
**NXWD** NX Wireless, Dual SmartPORTs<sup>14, 15</sup>
- Sensors**  
**SD1** Daylight Sensor Required. Enter quantity. 2SD1 = 2 daylight sensors/row  
**SO1** Occupancy Sensor Required. Enter quantity. 2SO1 = 2 occupancy sensors/row  
**SZ1** Zigbee Radio Module Required. Enter quantity. 2SZ1=2 radio modules/row. Radio controls up to 10 drivers. Must be ordered with D00.

## Notes:

- Ceiling type can not be retrofitted in the field.
  - Excludes individual grid mounts
  - Not Available with Patterns.
  - Visit [www.litecontrol.com/finishes](http://www.litecontrol.com/finishes) for details.
  - Additional lead time may be applicable. Contact factory.
  - Must be ordered with D05 Driver option; excludes 2' lengths and patterns.
  - Specifiable in 50 lumen increments. Reference the Performance Data Table for full performance offering and exceptions.
  - D030 not available in 2'
  - Must be ordered with 2230TD, 2750T or 2765T Option
  - Excludes Emergency Battery Pack 'EF' Option. Excludes DALI, DALIP and Lutron (LEC) Dimming Drivers
  - EF - 10W battery powered driver. Provides a minimum of 90 minutes of emergency lighting. Inverter-Compatible. Provided by others.
  - Only applicable when specified with Emergency/Nightlight.
  - Contact Factory for pattern configurations. Approval drawings required.
- NX In-Fixture Control Options:**
- Not available for row mounting. Only available with 0-10V Driver options. Contact factory for Length restrictions.
  - Refer to [NX Integrated Controls Reference Table](#) for Functionality of Options.
  - NX Sensors with Bluetooth, BLE, provides remote commission only.

# 6L-R-D

MOD™ 6 LED RECESSED DIRECT

## CONTROLS



### NX Distributed Intelligence™ Lighting Controls:

Supports both indoor and outdoor applications in a variety of deployment options- wired, wireless, hybrid. Integrates with and enables a wide array of luminaires including those with SpectraSync Color Tuning Technology.

NX INTEGRATED CONTROLS REFERENCE								
NX Option	Sensor	Networkable	Scheduling	Occupancy	Daylight Harvesting	0-10V Dimming	On/off Control	Bluetooth® App Programming
<b>NX Standalone</b>								
NXS	NXSMP-SMI	No	Yes	Yes	Yes	Yes	Yes	Yes
<b>NX Networked – Wired</b>								
NXE	N/A	Yes	Yes	No	No	Yes	Yes	Requires NXBTC/R <sup>1</sup>
NXES	NXSMP-SMI	Yes	Yes	Yes	Yes	Yes	Yes	Yes
<b>NX Networked – Wireless</b>								
NXSW	NXSMP-SMI	Yes	Yes	Yes	Yes	Yes	Yes	Yes
NXWE <sup>2</sup>	N/A	Yes	Yes	No	No	Yes	Yes	No <sup>3</sup>
<b>NX Networked – Wired/Wireless</b>								
NXSWD	NXSMP-SMI	Yes	Yes	Yes	Yes	Yes	Yes	Yes
NXWD	N/A	Yes	Yes	No	No	Yes	Yes	Requires NXBTC/R <sup>1,3</sup>

- 1 NXBTC/R needs to be plugged into an available NX SmartPort™ on the fixture network
- 2 Programming via App requires factory assistance
- 3 To program NXWE option, need to consult factory. If connected to an area controller, programming can be done from that

### SpectraSync™ Color Tuning Technology:

Control your space based on the needs of the application, specific activities throughout the day and preferences of the occupants with distinct SpectraSync™ Color Tuning Technologies.



SPECTRASYNCH COLOR TUNING TECHNOLOGY		
Mode	Kelvin Range	Description
Dim to Warm	2200K-3000K	Mimics the familiar warming effect that occurs with traditional incandescent sources as they are dimmed
Tunable White	2700K-5000K 2700K-6500K	Offers users the ability to tailor CCT to their personal preference, enhancing task visibility, material and colors or the aesthetics of the space
Scheduled White	2700K-5000K 2700K-6500K	Mimics the rhythm of natural light or follows an alternative user-defined schedule throughout the day, enhancing an occupant's mood and well-being

### SpectraSync Tunable White

Available in two options: 2750T (2700K–5000K) or 2765T (2700K–6500K). Requires two 0–10V controllers, one for intensity and one for CCT. Minimum 5% dimming.

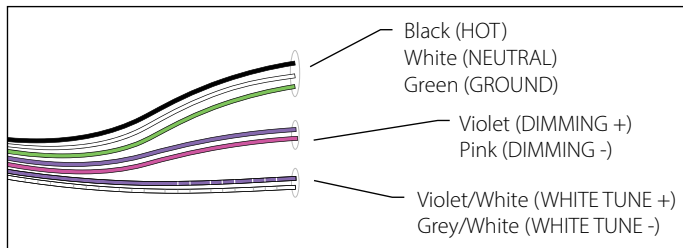

SpectraSync Tunable White luminaires are provided with two 0–10V circuits. The violet and pink circuit is for wiring to any qualified 0–10V controller for dimming. The violet/white and grey/white circuit is for wiring to any qualified 0–10V controller for Tunable White CCT control.

### Controller Manufacturer Data

SpectraSync Tunable White was designed to be used with sinking style dimmers (provided by others) and is compatible with:

- Hubbell Control Solutions (HCS): NX Distributed Intelligence™ Room Controllers (NXRC) and In-fixture Controllers (NXFM)
- Lutron: DDTV, DVSTV, and NDTV dimmers
- Wattstopper: ADF120277 and CD4BL (Titan) dimmers

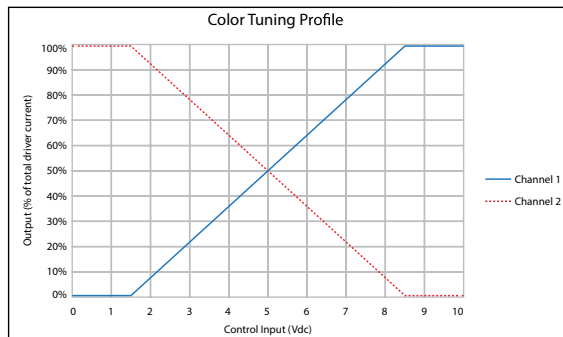

# 6L-R-D

MOD™ 6 LED RECESSED DIRECT

## PERFORMANCE DATA TABLE

The table below shows the delivered lumens for the various lumen outputs. Use this chart in connection with the output multiplier capability to deliver any output required.

Nomenclature	Lumens/Ft	W/Ft	Efficacy
<b>Downlight</b>			
D030 (min)	300	2.6	118
D035	350	3.0	118
D040	400	3.4	119
D045	450	3.8	119
D050	500	4.1	119
D055	550	4.6	119
D060	600	5.0	119
D065	650	5.5	119
D070	700	5.9	119
D075	750	6.4	119
D080	800	6.8	118
D085	850	7.2	118
D090	900	7.7	118
D095	950	8.1	117
D100	1000	8.6	117
D105	1050	9.0	117
D110	1100	9.5	116

(wattage may vary up to 5% from published)

### Output Restrictions

Driver options listed below are not available for the output and length as shown.

Restrictions - Direct		Output LPA				
		300	350	400	450	500
Length (feet)	2	LEC, DALI, 347V	LEC, DALI, 347V	DALI, 347V	DALI, 347V	DALI, 347V
	3	DALI, 347V	DALI, 347V			

### Output Multiplier Table

Photometrics for the 4L are published here at a nominal 3500K temperature. This table may be used to approximate the lumen values at different Kelvin temperatures. Power consumption would stay the same.

Option	2700K	3000K	3500K	4000K	5000K	2700K 90 CRI	3000K 90 CRI	3500K 90 CRI	4000K 90 CRI	5000K 90 CRI
SOF	0.95	0.98	1.00	1.03	1.05	0.83	0.85	0.88	0.90	0.93
REG	0.73	0.75	0.77	0.79	0.81	0.64	0.65	0.68	0.69	0.72
BWO	0.67	0.69	0.70	0.72	0.76	0.63	0.53	0.47	0.42	0.39
BAT	0.95	0.98	1.00	1.03	1.05	0.83	0.85	0.88	0.90	0.93
LPAD	0.86	0.88	0.90	0.93	0.95	0.75	0.77	0.79	0.81	0.84

# 6L-R-D

MOD™ 6 LED RECESSED DIRECT

## DIMENSIONS

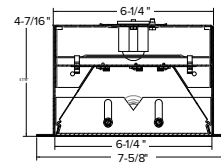
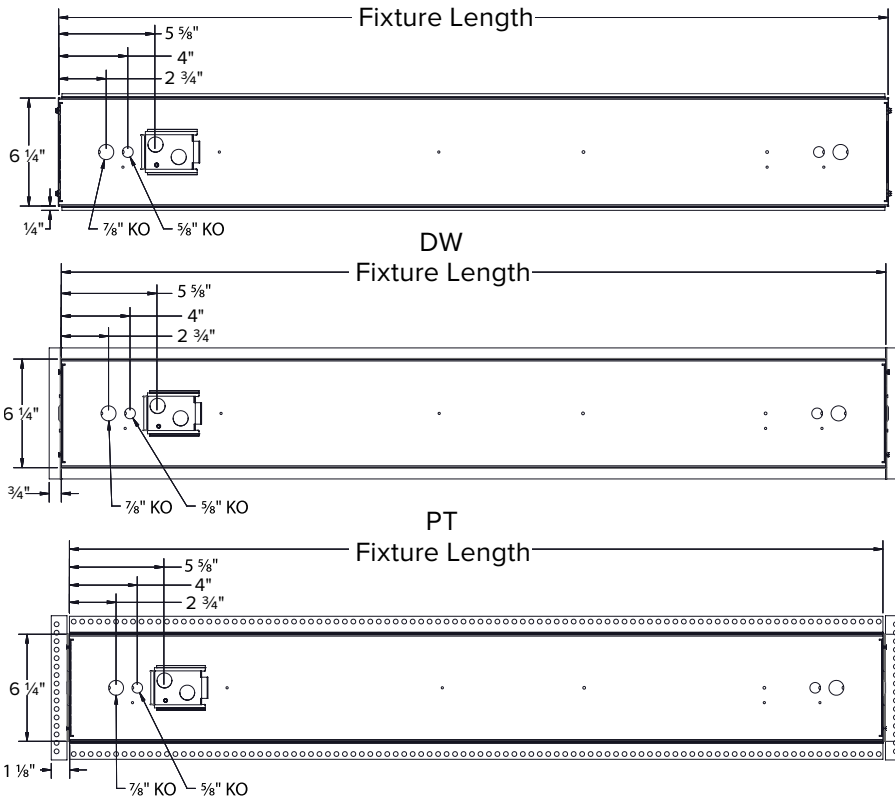

6L-DW

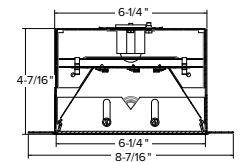

6L-PT

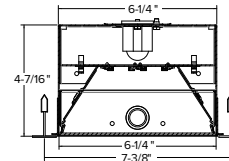

6L-LG

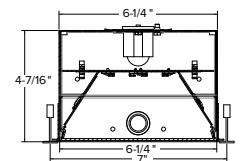

6L-NG

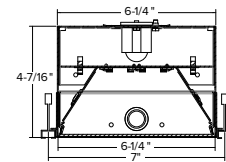

6L-SS

## INDIVIDUAL MOUNTING

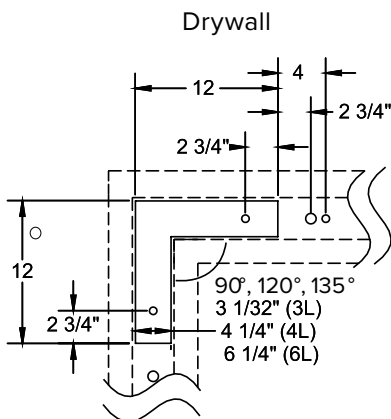

○ = 5/8" DIA. KO'S FOR 1/4-20 THREADED ROD  
○ = 7/8" DIA. FEED KO'S

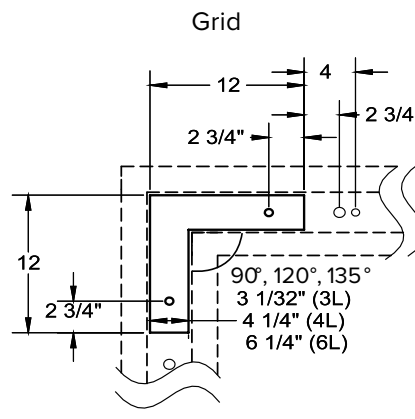

○ = 5/8" DIA. KO'S FOR 1/4-20 THREADED ROD  
○ = 7/8" DIA. FEED KO'S

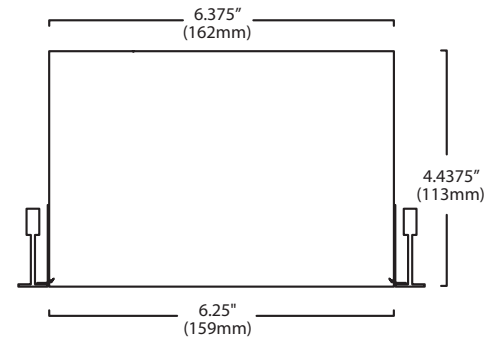

END CAP VIEW

PATTERNS

# 6L-R-D

MOD™ 6 LED RECESSED DIRECT

## PHOTOMETRY

### 6L-R-D-04-SOF-X-CX-35K-D100

#### LUMINAIRE DATA

Description	6L Recessed, Soft Diffuse Lens, 3500K
Delivered Lumens	4000
Watts	
Efficacy	118
Mounting	Recessed

#### ZONAL LUMEN SUMMARY

Zone	Lumens	% Luminaire
0-40	1884.30	47.1
0-60	3205.40	80.1
0-90	3999.70	100.0
0-180	4000.30	100.0

#### POLAR GRAPH

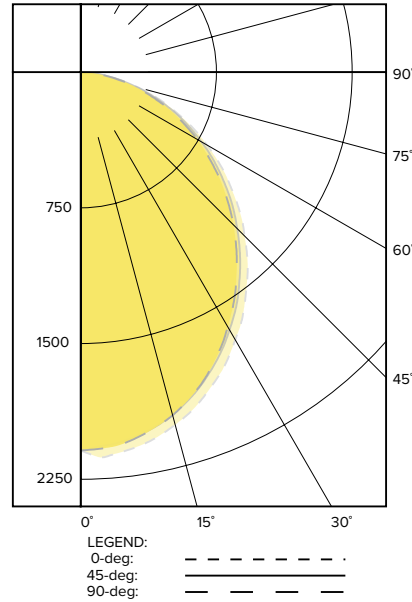

### 6L-X-D-04-BAT-CX-35K-D100

#### LUMINAIRE DATA

Description	6L Recessed, Batwing Lens, 3500K
Delivered Lumens	4000
Watts	36
Efficacy	111
Mounting	Recessed

#### ZONAL LUMEN SUMMARY

Zone	Lumens	% Luminaire
0-40	1746.36	43.68
0-60	3169.33	79.26
0-90	3998.46	100.00
0-180	3998.46	100.00

#### POLAR GRAPH

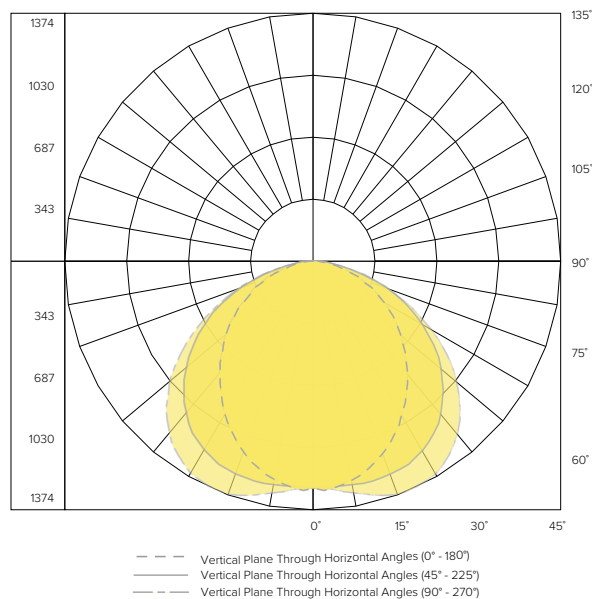

# 6L-R-D

MOD™ 6 LED RECESSED DIRECT

## TM-30 DATA

### COLOR VECTOR GRAPHIC

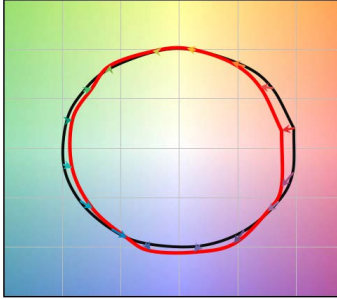

### COLOR DISTORTION GRAPHIC



TEST RESULTS - 3500K	
Value	80+ CRI
CCT (K)	3494
CIE R <sub>a</sub>	83
D <sub>uv</sub>	-0.0004
R <sub>f</sub>	82
R <sub>g</sub>	96
x	0.4052
y	0.3898

\*Graphics shown are at 35K

— Reference Illuminant — Test Source

### COLOR CHARACTERISTICS:

Value	Ordering Code		
	30K	35K	40K
R <sub>f</sub>	83	82	82
R <sub>g</sub>	96	96	96
CCT (K)	3009	3494	3975
D <sub>uv</sub>	-0.0009	-0.0004	-0.0003
x	0.435	0.4052	0.3814
y	0.4012	0.3898	0.3768
CIE Ra	83	83	84

### SPECTRAL DISTRIBUTION:

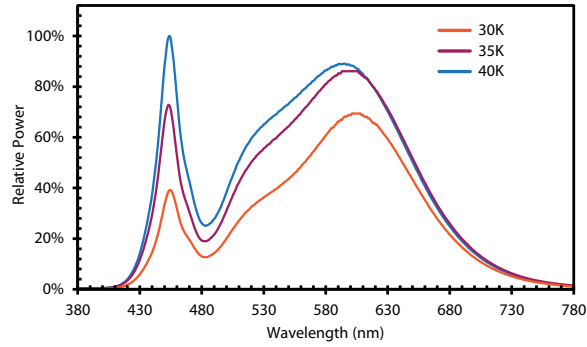

### COLOR VECTOR GRAPHIC:

30K

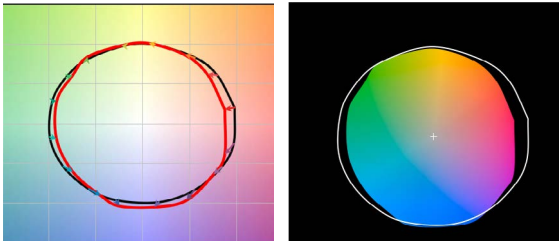

35K

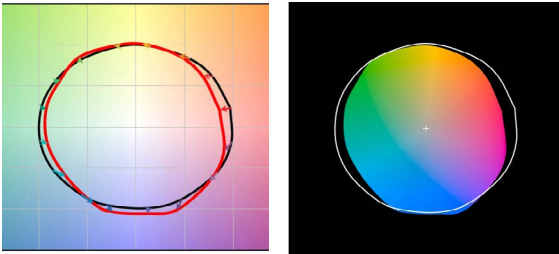

40K

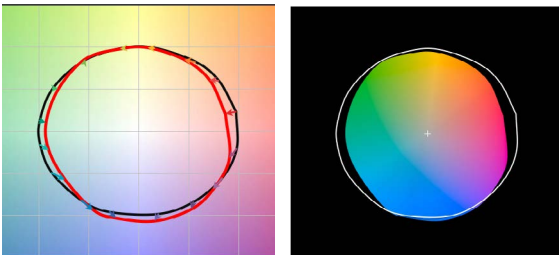

### COLOR GAMUT/FIDELITY PLOT:

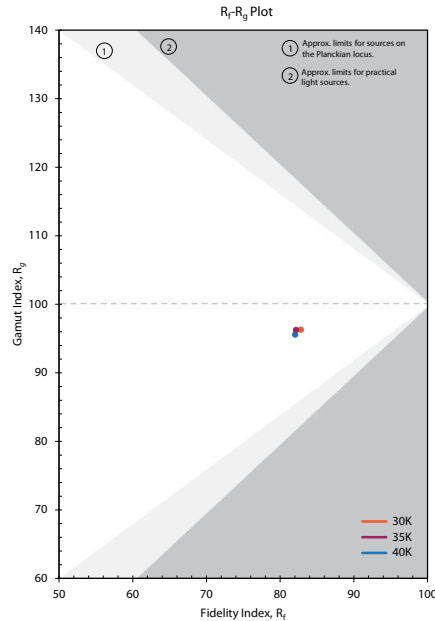

### CRI: 80 MINIMUM

CCT	CRI	R1	R2	R3	R4	R5	R6	R7	R8	R9	R10	R11	R12	R13	R14
30K	83	82	91	97	81	82	89	84	62	13	79	79	69	84	99
35K	83	81	89	95	81	81	85	86	65	13	73	79	62	83	97
40K	84	82	90	94	82	82	85	87	68	17	74	80	60	84	97

# 6L-R-D

MOD™ 6 LED RECESSED DIRECT

DATE: \_\_\_\_\_ LOCATION: \_\_\_\_\_

TYPE: \_\_\_\_\_ PROJECT: \_\_\_\_\_

CATALOG #: \_\_\_\_\_

## ADDITIONAL INFORMATION

### Driver

D01	100%- 1% dimming range. Fixture will be wired for low voltage 0-10V dimming control.
D00	Dim-to-Off 100%-1% dimming range. Fixture will be wired for low voltage 0-10V dimming control.
D05	100%-5% dimming range, Fixture will be wired for low voltage 0-10V dimming control. Only applicable if either 2230TD, 2750T or 2765T is selected.
DS1	Soft-Start 100%-1% dimming range. Fixture will be wired for low voltage 0-10V dimming control.
DS0	Soft-Start Dim-to-Off 100%-1% dimming range. Fixture will be wired for low voltage 0-10V dimming control.
LEC	Hi-Lume 1% EcoSystem LED Driver with Soft-On, Fade-to-Black dimming technology.
DALI	DALI compatible.
DALIP	Self-Powered DALI bus (e.g. DEXAL)
NDM	Non-dimming. Fixture will be wired for fixed light output.

### Rated Life

Tested in accordance to LM79-2008 & derived from EPA TM-21 calculator

L70: 280,000 (calculated per TM-21 extrapolated curve)

L70: >61,000 (reported per TM-21/LM80 6x's limitation)

L90: 72,000 (calculated per TM-21 extrapolated curve)

L90: >61,000 (reported per TM-21/LM80 6x's limitation)

### Rated Life (Driver)

Standard = 100,000 hours

Lutron = 50,000 hours