

A1B2-600-2

by CMC

Catalog ID: A1B2-600-2

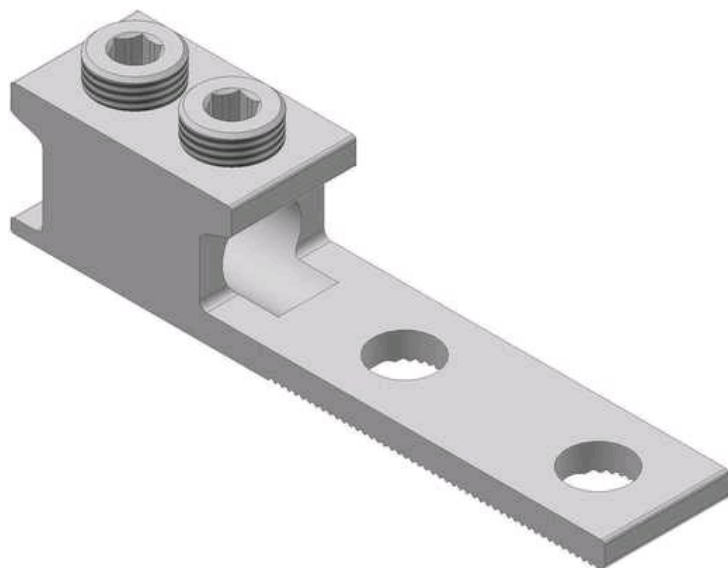

Single Hole Solderless Lug with wire range 600 AWG -2 AWG. TYPE: ABSG/A1B2-2 .The unique ridges formed on the bottom of the contact surface are designed to provide contact points for an electrically secure joint of the lowest resistance for current flow. The screws used to clamp the conductors are designed to extend beyond the barrel sides of the conductor to allow a better, more secure compression of the conductor. This design spreads the conductor strands to help dissipate heat, and improve its pull-out safety features and capabilities. The design of the wire way provides optimum transfer of current, creating a straight line flow through the connector for the least possible path of electrical resistance. A positive wire stop is also provided. 90° C Rated (486B Listed). UL listed and CSA certified.

Product Details

General

Material	Aluminum
Type	Bolted Lugs & Terminals
UPC	192663019199

Dimensions

Height	1.56 in
Length	5.62 in
Thickness	0.38 in
Width	1.5 in

Conductor Related

Conductor - Copper Str Size Range	600 Kcmil-2 AWG
-----------------------------------	-----------------



CONNECTOR MANUFACTURING COMPANY
3501 Symmes Road
Hamilton, Ohio 45015 - 1369
513 - 860 - 4455(Press 2 for Customer Service and Sales)
To email customer Service: [jrex @cmclugs.com](mailto:jrex@cmclugs.com)

