

BFGBS224818

by CMC

Catalog ID: BFGBS224818

Fiberglass Cabinet Bases/Foundations

- Non-corrosive and non-conducting base/foundation for mounting sectionalizing cabinets, fusing cabinets or similar applications
- Allows ample space for training cables
- Easily drilled to accept mounting hardware
- Eliminates any concern with corrosion degradation common with metal foundations
- The base is manufactured from durable, non-corrosive, thermoset polyester resin reinforced with fiberglass
- The base is maintenance free
- Internal or external ribs provide structural integrity and uniform nesting
- The bases can be re-stacked and transported without binding

Other sizes available upon request.

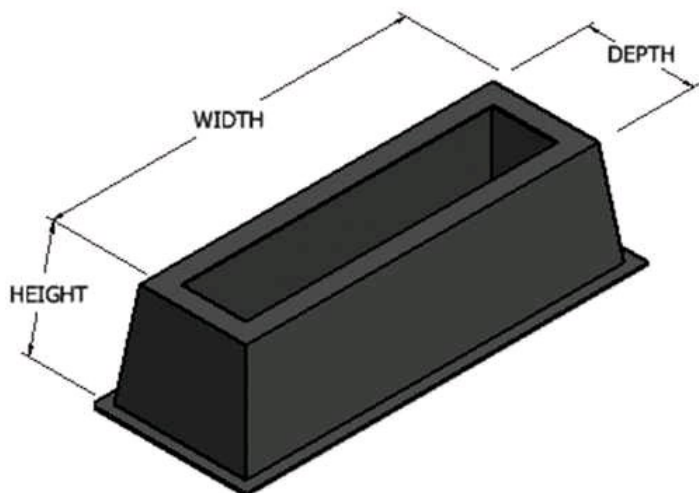

Product Details

General

UPC	192663131358
-----	--------------

Dimensions

Depth	20.5 in
Height	18 in
Width	48 in