

BGSBS223620

by CMC
 Catalog ID: BGSBS223620

Primary Sectionalizing Enclosure Burial Sleeve

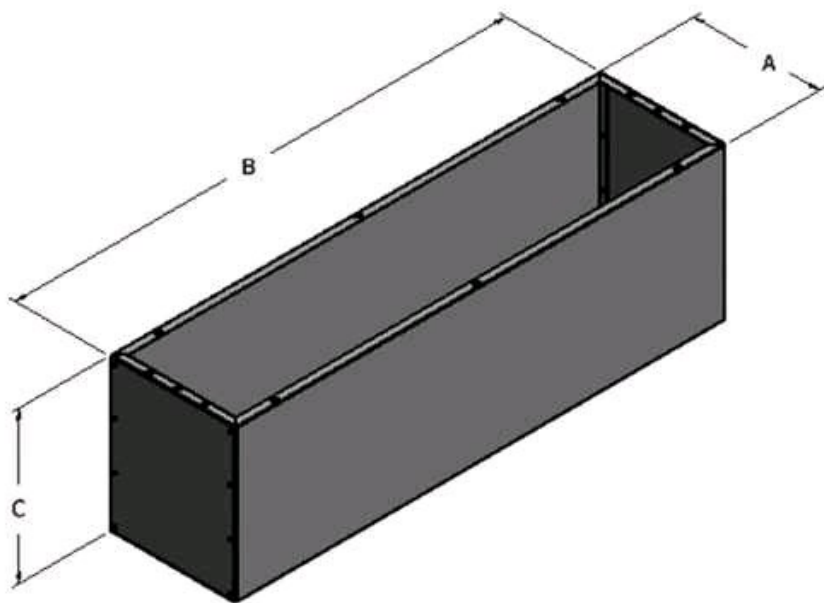

- All steel burial sleeves are fabricated from 14-gauge galvanized steel and have an oven cured powder coat polyester finish. (Also available in aluminum as “BA” catalog number, e.g.: BABS228420)
- 12 gauge galvanized steel available upon request (add suffix “-H”)
- 304 stainless steel carriage bolts supplied for assembly

Product Details

General

Material	Steel, Galvanized
----------	-------------------

Dimensions

Depth	20.5 in
Height	20 in
Width	36 in