



DATE: \_\_\_\_\_ LOCATION: \_\_\_\_\_  
 TYPE: \_\_\_\_\_ PROJECT: \_\_\_\_\_  
 CATALOG #: \_\_\_\_\_

# Trident TRF Series

THREE-PHASE CENTRAL LIGHTING INVERTER 10KVA - 125KVA



## FEATURES

- Uninterruptible, "no break" design transfers the load instantaneously when normal power is interrupted
- 100% load compatible with any lighting source, including HID
- Double conversion technology protects against a wide range of input power disturbances
- Handles deep power line "sags" without transferring to battery power
- Overload and short-circuit protection
- Smallest overall system width in the industry
- Internal maintenance bypass switch included standard
- Intuitive graphic user interface includes indicators and alarms
- Maintenance-free batteries pre-mounted and wired for lower installation costs
- Form C contact closure points included standard



OSHPD 2015 IBC

**FACTORY START-UP**  
 Required to be ordered with all TRF series inverters

## SPECIFICATIONS

### APPLICATION

- The Trident TRF Series offers quiet reliable operation for commercial office applications yet is rugged enough for manufacturing environments
- The ability to support three-phase AC power improves load efficiency, allows output load balancing and easy building electrical system integration
- Precisely controlled system output is suitable for any lighting or critical life safety load up to the full rated output capacity
- Technical support is available from a nationwide network of factory-trained technicians

### OPERATION

- AC output provides full lumen output for emergency lighting loads in commercial or industrial applications
- Uninterruptible "no break" transfer provides seamless switching from normal to emergency AC power
- "Double conversion" design completely isolates the line from the load, eliminating the impact of line disturbances and providing more precise output load regulation
- Internal maintenance bypass switch is standard

### OPERATION (CONTD.)

- 60 Hz operation (50Hz upon request)
- Sizes available: 10 through 125 KVA
- 24 hour recharge time
- 90 minute emergency operation supplied standard

### CONSTRUCTION

- Intuitive graphic user interface includes indicators and audible alarms to provide system status
- Electronics and battery cabinets constructed of heavy duty steel, with a black powder coat painted finish
- All cabinets are equipped with casters or leveling feet
- Systems arrive with maintenance-free batteries pre-mounted and wired
- Retractable, front access battery trays provided for easy maintenance
- Standard bottom cable entry provided; top cable entry optional
- Seismic rating is standard on 65-125kVA models; available with optional mounting accessories on 10-60kVA models
- Smallest overall system widths in the industry
- System widths as low as 49"
- Form C contact closure points standard on all models
- Manually operated internal maintenance bypass switch included standard

### CERTIFICATIONS/COMPLIANCES

- UL Listed to Standard 924 (Emergency Lighting)
- NFPA 101 (Life Safety Code)
- NFPA 111 (Stored Emergency Power Supply Systems - SESS)
- NFPA 70 (National Electrical Code)
- IBC 2015 (OSHPD Seismic Certified)
- OSHPD seismic approval on greater than or equal to 65KVA, bracing on less than 65KVA
- IFC Compliance with Optional battery monitoring
- NEMA 3R available upon request; consult factory

### WARRANTY

- Unit: 2 year
- Batteries: 10 Years (1 year full, 9 year pro-rata)<sup>4,5</sup>  
 Start-up must be performed by an Authorized Service Center within 6 months of shipment to maintain battery warranty.  
  
 Batteries must be connected to an energized charging circuit within 90 days from date of shipment or warranty is void.
- See [HLI Standard Warranty](#) for additional information

KEY DATA	
Wattage Range	9kW - 112kW
Overload	125% for 10 min. / 150% for 1 min.
Input/Output (VAC)	208/208VAC, 480/480VAC or 480/208VAC



DATE: \_\_\_\_\_ LOCATION: \_\_\_\_\_

TYPE: \_\_\_\_\_ PROJECT: \_\_\_\_\_

CATALOG #: \_\_\_\_\_

# Trident TRF Series

THREE-PHASE CENTRAL LIGHTING INVERTERS 10KVA - 125KVA

## ORDERING GUIDE

Example: TRF-208-3-40-208-AFH

CATALOG # \_\_\_\_\_

TRF Model	Input Voltage	Input Conductor	Capacity	Output Voltage (VAC)	Options <sup>6, 7, 8, 9, 10</sup>
TRF Trident TRF 3-phase inverter	208 208VAC <sup>1</sup>	3 3 Wire	10 10KVA/9KW	208 208VAC	A SNMP/Web Card
	480 480VAC	4 4 Wire <sup>2</sup>	15 15KVA/13KW	480 480VAC <sup>3</sup>	B SNMP/Web Card & Env. Sensor
			20 20KVA/18KW		C Top Entry Cabinet
			30 30KVA/27KW		D SNMP Card & Top Entry Cabinet
			40 40KVA/36KW		E SNMP Card, Env. Sensor & Top Entry Cabinet
			50 50KVA/45KW		F IFC Compliant Battery Monitoring
			60 60KVA/54KW		H Single Pole Power Distribution
			65 65KVA/58KW		J 2-pole Power Distribution
			80 80KVA/72KW		K 3-pole Power Distribution
			100 100KVA/90KW		
		125 125KVA/112KW			

### Factory Start-Ups (Required)<sup>4</sup>

FST-1	Factory Start-Up 10-30kVA
FST-2	Factory Start-Up 40-80kVA
FST-3	Factory Start-Up >80kVA

### Accessories

TRF-RSP-1	Remote Status Panel 10-60kVA
TRF-RSP-2	Remote Status Panel 65-125kVA
TRF-SFK-1	Seismic Mounting 10-40kVA
TRF-SFK-2	Seismic Mounting 50-60kVA

## SPECIFICATIONS

### INPUT

**Voltage:** 208 or 480VAC, 3-wire or 4 wire plus ground  
**Voltage Range:** +15%, -20% (up to 60kVA), -10% (>60kVA)  
**Frequency Range:** 60Hz., +/- 5Hz.  
**Current Distortion:** < 1% (up to 60kVA), <3% (>60kVA) maximum reflected THD at full load  
**Current Limit:** 115 - 120% (109% for 125kVA) of nominal AC input current maximum  
**Power Factor Range:** 0.99 at full load.

### OUTPUT

**Voltage:** 208/120, 480/277VAC, 3-wire or 4-wire plus ground  
**Static Voltage Regulation:** ±2.0% for up to 60kVA, ±1% for >60kVA  
**Voltage Transient Response (Linear Loads):** ± 2% for up to 60kVA, ±1% for >60kVA  
**Voltage Transient Response (Non-Linear Loads):** ±5% for up to 60kVA, ±3% for >60kVA  
**Phasing Balance:** 120° ±1° for balanced and unbalanced load  
**Frequency Stability (without by-pass line synchronization):** ±0.02% for up to 60kVA, ±0.05% for >60kVA  
**Load Power Factor Range:** 0.9 leading to 0.5 lagging without derating (may not exceed KVA rating)  
**Overload:** 125% of full load for 10 minutes; 150% for one minute

### Notes:

- 1 Only available with 208VAC output voltage
- 2 Available with 480VAC output voltage (all capacities), and with 208VAC input voltage on 10kVA through 65kVA capacities
- 3 Only available with 480VAC input voltage
- 4 Start-up must be performed by an Authorized Service Center within 6 months of shipment to maintain battery warranty
- 5 Batteries must be connect to an energized charging circuit within 90 days from date of shipment or warranty is void
- 6 Alternate run times and 50Hz models available on request; consult factory
- 7 SNMP/Web Card: Internal SNMP Card allows inverter management across a LAN using any of the main network communication protocols - TCP/IP, HTTP and network interface (SNMP) SNMP/Web Card & Env. Sensor: SNMP card with environmental sensor module that senses temperature, humidity and smoke and displays it via SNMP.  
Top Entry Cabinet: Provides additional side-mounted compartment to allow for top conduit entry. This option adds 4.75 inches to the width and 6 inches to the depth of the 10-40kVA unit. It adds 15.75 inches to the width of the 65-125kVA unit  
Top Entry Cabinet is standard on 50 and 60kVA units.
- 8 Power distribution available on 10-40kVA sizes; includes nine (9) unmonitored, 20A output breakers
- 9 Power distribution options include Top Entry Cabinet
- 10 IFC Compliant Option provides string-level battery monitoring; Certified by UL to detect and preclude thermal runaway

### GENERAL

#### Operating Temperature Range:

Electrical Cabinet: 0°C to 40°C (32°F to 104°F)  
 Battery Cabinet: 20°C to 30°C (68°F to 86°F)

**Relative Humidity:** 0-95% non-condensing

**Operating Altitude:** Up to 1000m without derating; derate capacity 1% per 100m from 1000m to 2000m for up to 60kVA systems and from 1000m to 4000m for >60kVA systems

**Acoustical Noise:** Less than 75 dBA for up to 60kVA, less than 68 dBA for >60kVA



DATE: \_\_\_\_\_ LOCATION: \_\_\_\_\_

TYPE: \_\_\_\_\_ PROJECT: \_\_\_\_\_

CATALOG #: \_\_\_\_\_

# Trident TRF Series

THREE-PHASE CENTRAL LIGHTING INVERTERS 10KVA - 125KVA

## CABINET CONFIGURATION

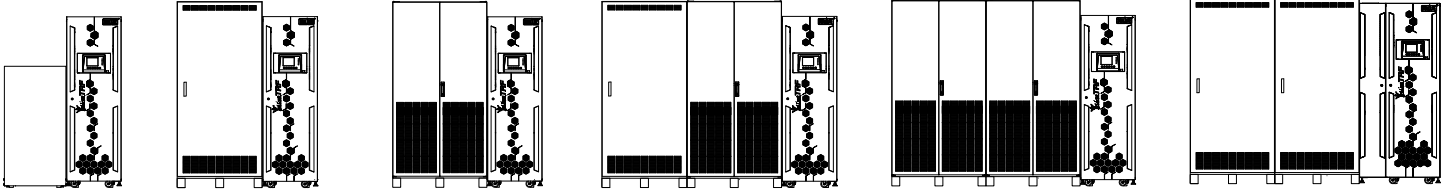

Configuration A

Configuration B

Configuration C

Configuration D

Configuration E

Configuration F

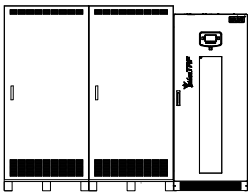

Configuration G

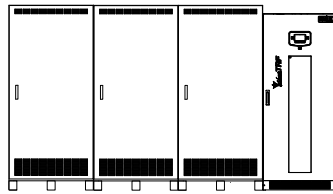

Configuration H

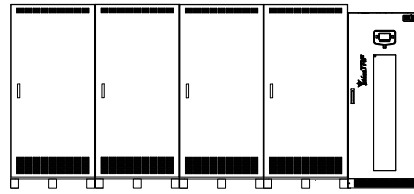

Configuration I

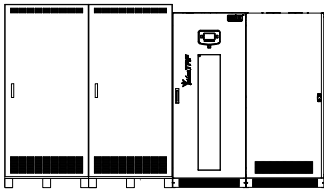

Configuration J

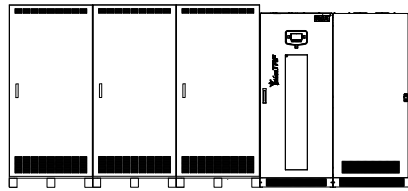

Configuration K

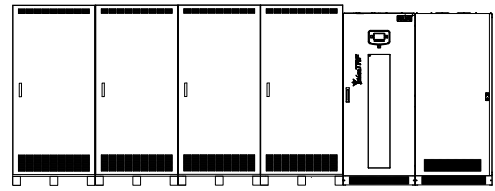

Configuration L

## TOP ENTRY CABINET CONFIGURATION

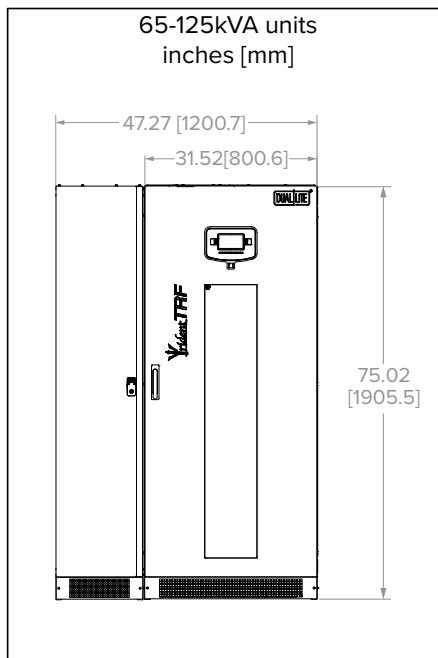
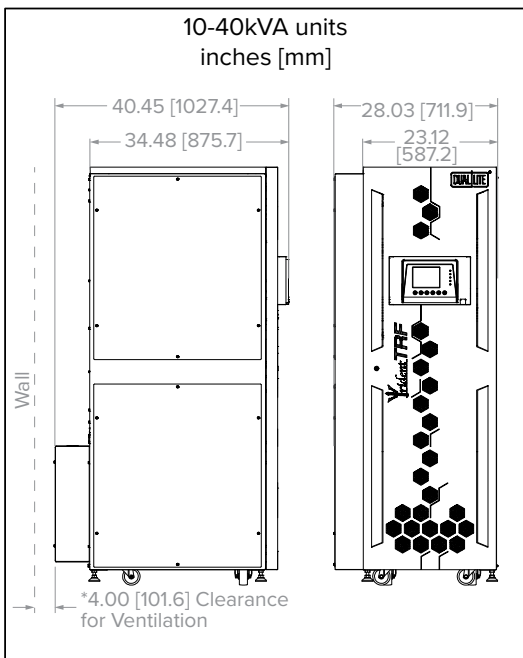



DATE: \_\_\_\_\_ LOCATION: \_\_\_\_\_

TYPE: \_\_\_\_\_ PROJECT: \_\_\_\_\_

CATALOG #: \_\_\_\_\_

# Trident TRF Series

THREE-PHASE CENTRAL LIGHTING INVERTERS 10KVA - 125KVA

## SITE PLANNING DATA

UPS Rating	AC Voltage			AC Current			Battery		Recommended OCPD			Mechanical Data						
	kVA/kW	Input (VAC)	Output (VAC)	Bypass (VAC)	Input Nom (A)	Input Max (A)	Output Nom (A)	Nom. (VDC)	Discharge (A)	Input	Output	DC	No. of Cab.	Cab. Config.	Width (in)	Depth (in)	Height (in)	Weight (lbs)
10/9	208V	208Y/120V	208V	27.8	33.4	27.8	432	26.5	45	35	35	2	A	49.2	35.6	72.4	2,351	3200
10/9	208Y/120V	208Y/120V	208/120V	27.1	32.6	27.8	432	26.5	40	35	35	2	A	49.2	35.6	72.4	2,171	2400
10/9	480V	208Y/120V	480V	12.1	14.5	27.8	432	26.5	20	35	35	2	A	49.2	35.6	72.4	2,381	3200
10/9	480V	480Y/277V	480V	12.2	14.7	12.0	432	26.9	20	15	35	2	A	49.2	35.6	72.4	2,481	3700
10/9	480Y/277V	480Y/277V	480/277V	12.1	14.5	12.0	432	26.9	20	15	35	2	A	49.2	35.6	72.4	2,371	3400
15/13	208V	208Y/120V	208V	41.7	50.1	41.6	432	39.8	70	60	50	2	B	59.1	34.5	78.7	3,439	4800
15/13	208Y/120V	208Y/120V	208/120V	40.7	48.8	41.6	432	39.8	60	60	50	2	B	59.1	34.5	78.7	3,189	3500
15/13	480V	208Y/120V	480V	18.1	21.7	41.6	432	39.8	30	60	50	2	B	59.1	34.5	78.7	3,439	4800
15/13	480V	480Y/277V	480V	18.4	22.0	18.0	432	40.4	30	25	60	2	B	59.1	34.5	78.7	3,639	5600
15/13	480Y/277V	480Y/277V	480/277V	18.2	21.8	18.0	432	40.4	30	25	60	2	B	59.1	34.5	78.7	3,589	5000
20/18	208V	208/120V	208V	55.7	66.8	55.5	432	53.1	90	70	70	2	C	63.1	34.5	78.7	4,319	6400
20/18	208Y/120V	208Y/120V	208/120V	54.3	65.1	55.5	432	53.1	80	70	70	2	C	63.1	34.5	78.7	4,089	4700
20/18	480V	208Y/120V	480V	24.1	28.9	55.5	432	53.1	35	70	70	2	C	63.1	34.5	78.7	4,389	6400
20/18	480V	480Y/277V	480V	24.5	29.4	24.1	432	53.9	40	30	70	2	C	63.1	34.5	78.7	4,619	7400
20/18	480Y/277V	480Y/277V	480/277V	24.2	29.1	24.1	432	53.9	40	30	70	2	C	63.1	34.5	78.7	4,549	6700
30/27	208V	208Y/120V	208V	83.5	100.2	83.3	432	79.6	125	110	100	3	D	99.1	34.5	78.7	6,509	9500
30/27	208Y/120V	208Y/120V	208/120V	81.4	97.7	83.3	432	79.6	125	110	100	3	D	99.1	34.5	78.7	6,079	7000
30/27	480V	208Y/120V	480V	36.2	43.4	83.3	432	79.6	60	110	100	3	D	99.1	34.5	78.7	6,509	9500
30/27	480V	480Y/277V	480V	36.7	44.1	36.1	432	80.8	60	50	110	3	D	99.1	34.5	78.7	6,774	11100
30/27	480Y/277V	480Y/277V	480/277V	36.4	43.6	36.1	432	80.8	60	50	110	3	D	99.1	34.5	78.7	6,609	10000
40/36	208V	208Y/120V	208V	111.3	133.6	111.0	432	106.2	175	150	150	3	E	103.1	34.5	78.7	7,953	12700
40/36	208Y/120V	208Y/120V	208/120V	108.5	130.2	111.0	432	106.2	175	150	150	3	E	103.1	34.5	78.7	7,519	9300
40/36	480V	208Y/120V	480V	48.2	57.9	111.0	432	106.2	70	150	150	3	E	103.1	34.5	78.7	7,969	12700
40/36	480V	480Y/277V	480V	49.0	58.8	48.1	432	107.8	80	70	150	3	E	103.1	34.5	78.7	8,239	14700
40/36	480Y/277V	480Y/277V	480/277V	48.5	58.2	48.1	432	107.8	80	70	150	3	E	103.1	34.5	78.7	8,059	13300
50/45	208V	208Y/120V	208V	147.1	176.5	138.8	432	132.7	225	175	175	3	F	106.4	34.3	78.7	9,621	19200
50/45	208Y/120V	208Y/120V	208/120V	143.4	172.0	138.8	432	132.7	225	175	175	3	F	106.4	34.3	78.7	9,041	14900
50/45	480V	208Y/120V	480V	63.7	76.5	138.8	432	132.7	100	175	175	3	F	106.4	34.3	78.7	9,451	19200
50/45	480V	480Y/277V	480V	65.4	78.4	60.1	432	136.1	100	80	175	3	F	106.4	34.3	78.7	9,861	23600
50/45	480Y/277V	480Y/277V	480/277V	65.4	78.4	60.1	432	136.1	100	80	175	3	F	106.4	34.3	78.7	9,861	23600
60/54	208V	208Y/120V	208V	170.6	204.8	166.5	432	159.3	250	225	200	3	F	106.4	34.3	78.7	9,599	24600
60/54	208Y/120V	208Y/120V	208/120V	166.4	199.7	166.5	432	159.3	250	225	200	3	F	106.4	34.3	78.7	9,041	19400
60/54	480V	208Y/120V	480V	73.9	88.7	166.5	432	159.3	110	225	200	3	F	106.4	34.3	78.7	9,601	24600
60/54	480V	480Y/277V	480V	75.1	90.1	72.2	432	161.7	110	100	225	3	F	106.4	34.3	78.7	10,167	27800
60/54	480Y/277V	480Y/277V	480/277V	74.3	89.2	72.2	432	161.7	110	100	225	3	F	106.4	34.3	78.7	10,173	25600
65/58	208V	208Y/120V	208V	180.5	209.0	180.4	480	159.5	300	225	160	4	J	137	33.5	78.7	12,539	26200
65/58	480V	480/277V	480V	78.2	89.0	78.2	480	159.5	125	125	160	4	J	137	33.5	78.7	11,909	15100
65/58	480V	208Y/120V	480V	78.2	89.0	180.4	480	159.5	125	225	160	4	J	137	33.5	78.7	11,909	26200
65/58	480Y/277V	480Y/277V	480/277V	78.2	89.0	78.2	480	159.5	125	100	160	3	G	103.6	33.5	78.7	10,439	15100
80/72	208V	208Y/120V	208V	222.2	256.0	222.1	480	196.4	350	300	200	5	K	173	33.5	78.7	17,009	32300
80/72	480V	480/277V	480V	96.3	109.0	96.2	480	196.4	150	150	200	5	K	173	33.5	78.7	16,379	32300
80/72	480V	208Y/120V	480V	96.3	109.0	222.1	480	196.4	150	300	200	5	K	173	33.5	78.7	16,739	32300
80/72	480Y/277V	480Y/277V	480/277V	96.3	109.0	96.2	480	196.4	150	125	200	4	H	139.6	33.5	78.7	14,909	18500
100/90	208V	208Y/120V	208V	277.6	317.0	277.6	480	235.8	400	350	250	5	K	173	33.5	78.7	17,119	40300
100/90	480V	480/277V	480V	120.3	136.0	120.3	480	235.8	175	175	250	5	K	173	33.5	78.7	16,489	40300
100/90	480V	208Y/120V	480V	120.3	136.0	277.6	480	235.8	175	350	250	5	K	173	33.5	78.7	16,489	40300
100/90	480Y/277V	480Y/277V	480/277V	120.3	136.0	120.3	480	235.8	175	150	250	4	H	139.6	33.5	78.7	15,019	23220
125/112	208V	208Y/120V	208V	347.1	360.0	347.0	480	294.8	450	450	300	6	L	209	33.5	78.7	21,722	50400
125/112	480V	480/277V	480V	150.4	160.0	150.4	480	294.8	200	200	300	6	L	209	33.5	78.7	21,092	50400
125/112	480V	208Y/120V	480V	150.4	160.0	347.0	480	294.8	200	450	300	6	L	209	33.5	78.7	21,092	50400
125/112	480Y/277V	480Y/277V	480/277V	150.4	160.0	150.4	480	294.8	200	200	300	5	I	175.6	33.5	78.7	19,622	28900

### NOTES FOR SITE PLANNING DATA:

- Input and bypass cables must be run in separate conduit from output cables.
- Minimum-sized grounding conductors to be per NEC 250-122. Parity-sized ground conductors are recommended. Neutral conductors to be sized for full capacity per NEC 310-15(B)(4) References are per NEC 2008.
- Wiring requirements:  
AC Input: 3-phase, 3-wire plus ground or 3-phase, 4-wire plus ground  
AC Output: 3-phase, 3-wire plus ground or 3-phase, 4-wire plus ground
- All wiring is to be in accordance with national and local electrical codes.
- Minimum cabinet access clearance: 3 ft. (0.9m) front; 18" (457mm) overhead for up to 65kVA systems and 24" (610mm) overhead for >65kVA systems; 8" (203mm) rear for up to 65kVA systems and 24" (610mm) rear for >65kVA systems.
- Top or bottom cable entry through removable access plates. Punch plate to suit conduit size then replace.
- Control wiring and power wiring must be run in separate conduit.
- Dimensions are system dimensions including UPS, battery cabinets and transformer cabinets (if any); Transformer cabinets are front access.

- Power distribution options (H,J,K) add approximately 8" to system width
- Weights are system weights including UPS, battery cabinets and transformer cabinets (if any); Transformer cabinets are front access.
- Heat dissipation includes UPS, battery and transformer cabinet.
- Recommended AC input external overcurrent protection is based on 80% rated devices and maximum input current limit settings.

### ADDITIONAL NOTES:

- If site configuration includes a back-up emergency generator, it is recommended that the engine generator set be properly sized and equipped for a UPS application. Generator options would typically include an isochronous governor (generator frequency regulation) and a UPS compatible regulator (generator voltage regulation). Consult generator manufacturer for required generator options and sizing.