

# FLB12 - 12" Floodlight Bracket for Pole

TENON BRACKETS AND ARMS ACCESSORY



## Compatible with:

Fixtures with 2" knuckle mount -ALSU, MSV, PT, VA

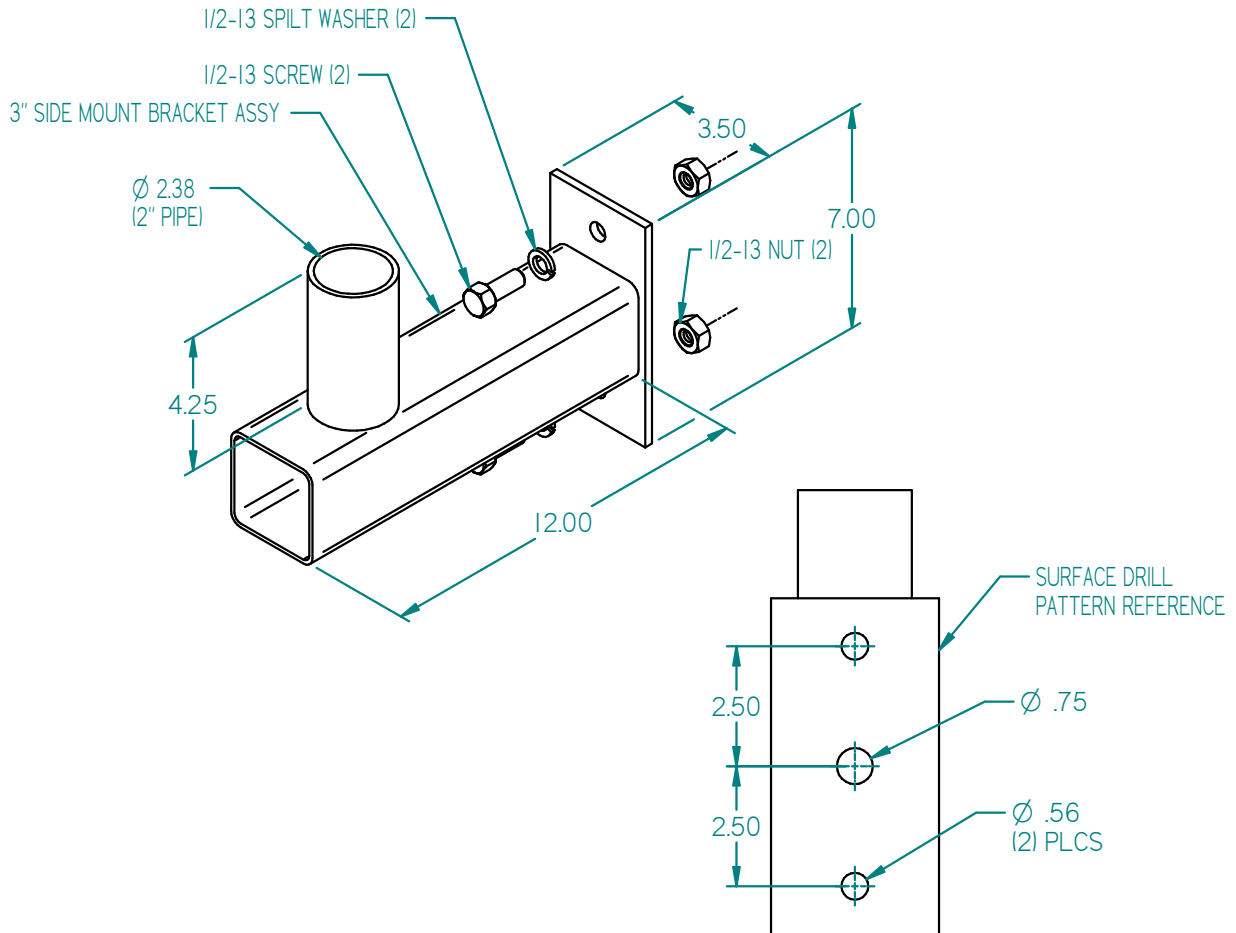

## Mounting Notes:

1. Position Floodlight bracket to desired mounting surface with the (2) holes lined up to predrilled holes in surface.
2. Secure with (2) 1/2-13 screws, (2) 1/2 split washers, and (2) 1/2-13 nuts.
3. Pull necessary wiring through middle 3/4" hole in bracket and up through tenon.
4. Install end cap.

## Shipping Package Contents:

- 24" FLB Bracket (1)
- End Cap (1)
- 1/2-13 Screw (2)
- 1/2 Split Washer (2)
- 1/2-13 Nut (2)

**Material:** Steel

**Finish:** Powder Paint

**Weight:** 10 lbs

**EPA:** .6 ft<sup>2</sup>