

POWERHUBB™ PoE LIGHTING & CONTROL



Project Name _____

Date _____

The Hubbell Control Solutions' (HCS) PowerHUBB node provides power distribution architecture and data connectivity to create a fully functioning Power over Ethernet (PoE) lighting control system. The PowerHUBB node implements a simplistic solution to controls by replacing the driver component and distributing direct control to the luminaire, achieving optimized power consumption.

Programming is performed using the Gateway software, which communicates bi-directionally over a Cat5e/6 Cable that connects directly to the PowerHUBB node. Master Nodes receive data and power from the PoE network switch. These nodes then pass along the power and data downstream to any daisy-chained Satellite node(s). Connected nodes/luminaires are automatically discovered by the Gateway, expediting commissioning and administering immediate feedback. Each Master node is DHCP-enabled and will automatically receive an IP address from the local network to simplify installation and setup.

Satellite Nodes extend the functionality and reach of a Master node by allowing Satellite nodes to be connected in a daisy-chain manner from the Master node via common Ethernet patch cables.

Product Features

- Replaces standard electronic AC driver in luminaire
- Programmed for optimized performance of LED
- Bi-directional communication
- Node is discovered immediately by Gateway software
- Low voltage inputs for control devices
- Provides dimming function down to 1%
- Direct connection to PSE device (PoE switch or midspan)
- Master nodes are DHCP-enabled
- Suitable for indoor applications
- Class 2 electrical device
- Plenum Rated
- Made in the USA

Compliance and Certification



Dimensional Data

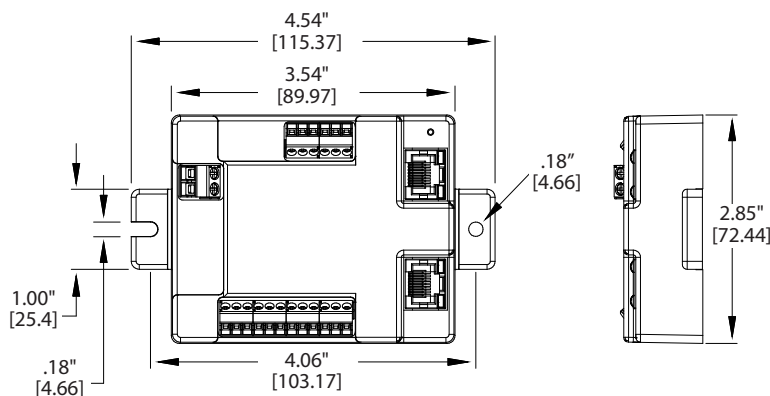

Ordering Information (Example: PHM1PC-100-1C-IND-1W100¹)

SERIES	TYPE	OUTPUT	PORTS	TOTAL PROGRAMMED VALUE (mA)	DISTRIBUTION	SCHEME	DIST. VALUE
PH PowerHUBB	M Master S Satellite	1 One	PC Power and Control	XXX0 ² Total milliamps for node	1C Single Channel	IND Independent	1Wxxx ² Channel Value

¹ True values are dependent on LED board and lumen package desired to be coordinated prior to ordering.
² Please replace xxx with desired mA programmed value in increments of 10 starting at 100 to 1750.

Wiring Diagrams

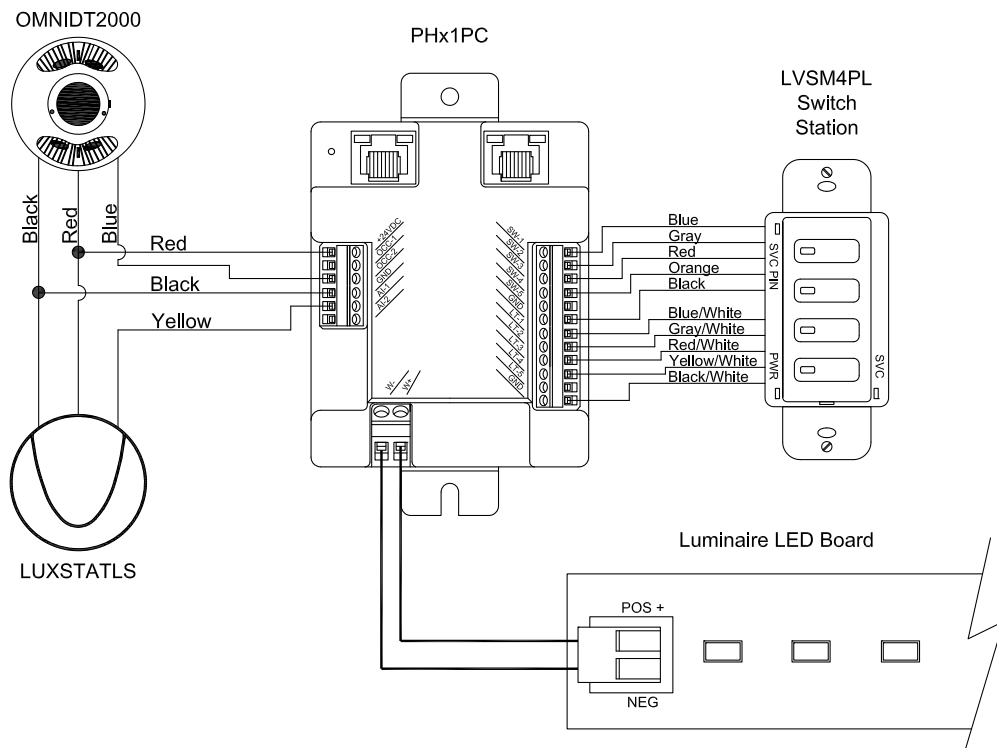

PowerHUBB Master Node with Occupancy Sensor, Daylight Sensor and Low Voltage 4 Button Switch Station

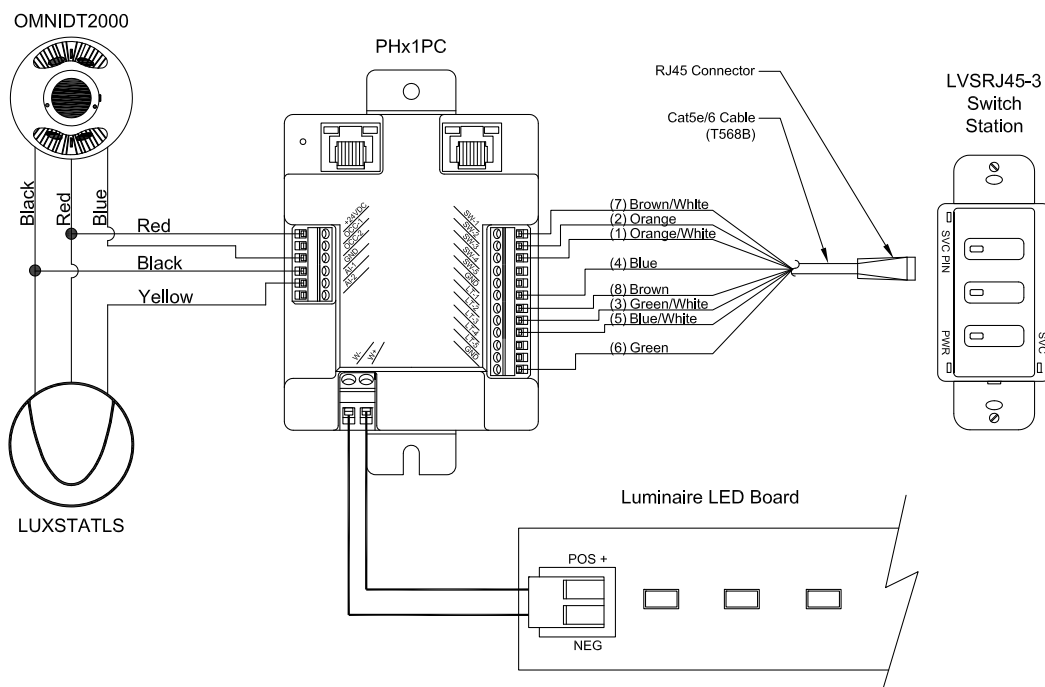

PowerHUBB Master Node with Occupancy Sensor, Daylight Sensor and Low Voltage, 3 Button, RJ45 Enabled Switch Station

Operating Window

Figure 1 shows the recommended output voltage and current ranges from the PowerHUBB Master and Satellite Nodes based on the specified node ambient temperatures. Driver performance cannot guarantee outside the operating window.

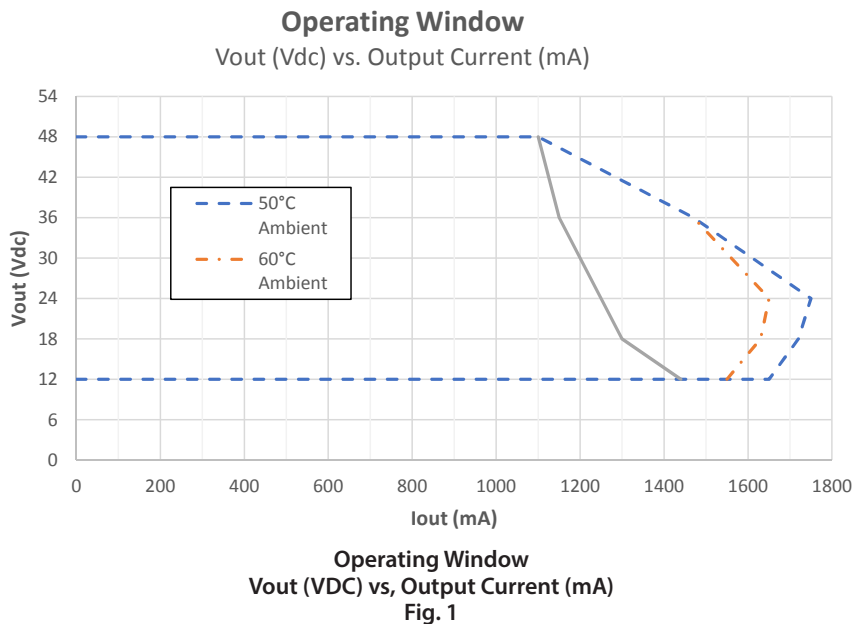

Driver Efficiency vs. Load Level

Figure 2 shows typical driver efficiency values for the full range of supported load voltages

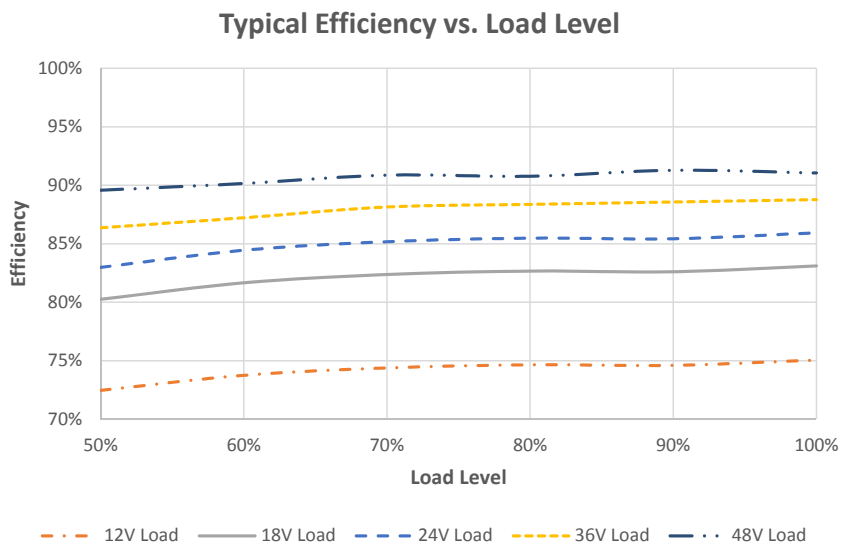

Output Current vs. Load Voltage

Figure 3 shows the maximum recommended output current settings based on load voltage and ambient temperature.

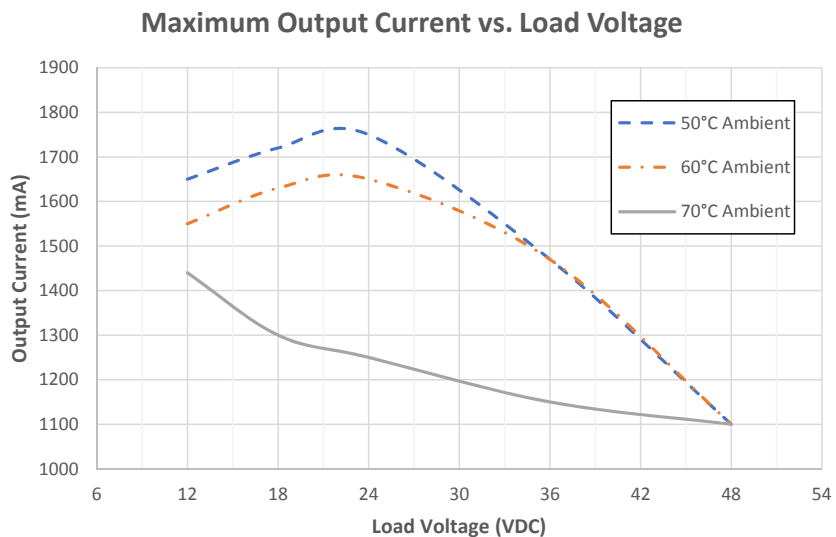

Maximum Output Current vs Load Voltage
Fig. 3

Output Power vs. Load Voltage

Figure 4 shows the maximum recommended output power level based on load voltage and ambient temperature.

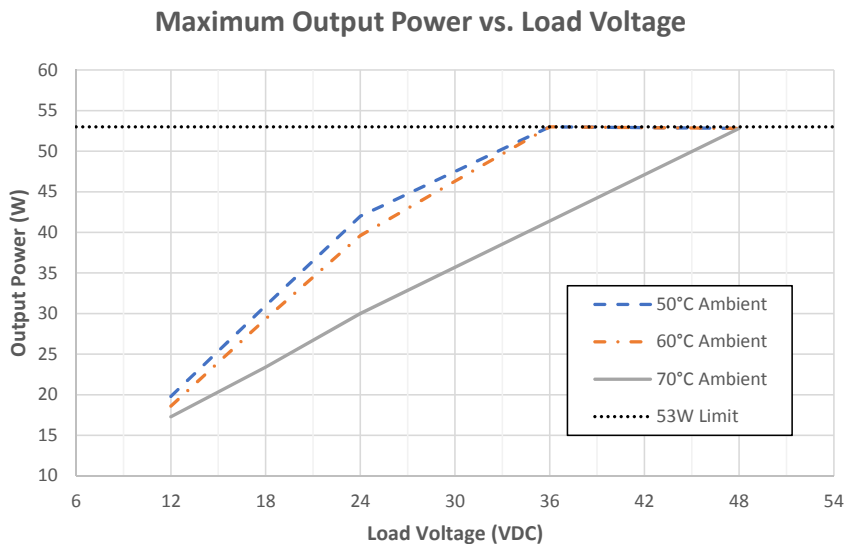

Maximum Output Power vs. Load Voltage
Fig. 4

Remote Mounting

Applications that call for remote mounting of the PowerHUBB nodes separate from the LED luminaire are acceptable. Please follow the maximum wiring distances listed in the table below when selecting an appropriate wire gauge.

Remote Mounting		AWG WIRE SIZES					
		12	14	16	18	20	22
OUTPUT CURRENT (mA)	350	900	566	356	224	141	89
	500	630	396	249	157	99	62
	700	450	283	178	112	70	44
	100	315	198	125	78	49	31
	1100	286	180	113	71	45	28
	1400	225	141	89	56	35	22
	1750	180	113	71	45	28	18
Max allowed distance between node and LED module in feet (Based on 1V drop)							

General Specifications

Electrical	PoE Interface(Master node only):	IEEE 802.3at-2009 PD Type 2, Class 4, Compliant Input with LLDP extensions for negotiating power above 30W using 4 pairs
	Input:	48-57VDC
	Peak operating power:	60W
	Nominal standby power:	2.0W
	PoE input connection:	Unshielded female RJ45 jack for use with Cat5e/6 cable to PSE device
	BUS connections:	Unshielded female RJ45 jack for use with Cat5e/6 cable to PowerHUBB Master or Satellite node
	Device type:	Class 2 electrical device
LED Driver Outputs	Output channel:	Single LED driver channel
	Driver design:	Constant current LED driver design, programmable in 10mA increments from 100mA to 1750mA (Refer to Fig. 1)
	Dimming:	Full range 1% to 100% dimming control in 1% increments via CCR, PWM or Hybrid mode
	Output voltage range:	12VDC - 48VDC
	Rated output power:	53W max
	Protection:	Short circuit and open circuit protection
	Connections:	Screw terminals; accept 14-26 AWG conductors. Tightening torque: 2.0-3.5 in-lbs. (0.35-0.4 Nm)
Sensor I/O Connections	Power supply:	One +24VDC terminal for powering external sensors, 500mA total capacity
	Occupancy sensor input:	OCC-1 for dry-contact sensor signals and OCC-2 for 24VDC Active-Hi sensor signals
	Analog sensor Inputs:	Two 0-10VDC analog sensor inputs
	Connections:	Screw terminals accept 16-26 AWG conductors. Tightening torque: 2.0-2.2 in-lbs. (0.23-0.25 Nm)
Wall Switch Connections	Switch inputs:	Five momentary dry contact pushbutton inputs
	Pilot light outputs:	Five pilot light outputs, rated for 24VDC@7.5mA each
	Connections:	Screw terminals accept 16-26 AWG conductors. Tightening torque: 2.0-2.2 in-lbs. (0.23-0.25 Nm)

General Specifications

Environment	For indoor use only	
	IP Rating	IP20
	Sound Rating	<24dB Class A
	Maximum case temperature:	185°F (85°C)
	Operating temperature:	32°F to 158°F (0°C to 70°C)
	Operating humidity:	10% to 80% RH non-condensing
	Storage temperature:	-4°F to 185°F (-20°C to 85°C)
	Storage humidity:	5% to 95% RH non-condensing
Mounting	Mounts inside Fixture can be mounted remotely. (see remote mounting chart)	
Dimensions-Overall	4.54" (115mm) L x 2.87" (73mm) W x 1.10" (28mm) H	
Dimensions-Mounting Tabs Removed	3.54" (90mm) L x 2.87" (73mm) W x 1.10" (28mm) H	
Color	Black	
Safety & EMC	Safety standards:	UL 2108, CAN/CSA C22.2 No. 9
		UL 1598C, CAN/CSA C22.2 No. 250.0-08, CSA B-79A
		UL 2043, Suitable for Use in Air Handling Spaces (Plenum Rated)
	EMC emissions:	Compliance to EN 55015:2013
	EMC immunity:	Compliance to EN 61547:2009
	FCC:	Compliance to Title 47 Part 15 Subpart B Section 15.109
EU:	RoHS Compliant	
Rated Lifetime	50,000+ hours	
Origin	Made in the USA	
Warranty	Five year limited	