

HLS Ladder Tray Tray Section

HUBBELL

90 Deg Outside Radius

Features

- HLS Ladder Tray is a modular system that is easily configured for all unique installations
- Ladder tray sections universally work with all ladder tray accessories
- HLS Ladder feature rung spacing every 9" to support and relieve cable stress

Ordering Information

Width	Type	Catalog Number	UPC Number
6"	90 Deg Outside Bend	HLO0690B	662620819662

Specifications

Material	Steel
Gauge	16
Construction	Tubing
Finish	Black
Radius	10"

Performance

Weight Capacity	45 lbs/ft
-----------------	-----------

Accessories

Protective End Caps	HLCEPK2
Cable Waterfall, 6"	HLCD06
Retaining Post, 6", Black	HLP06B
Black Velcro Roll	HVFBK575
9" Velcro Strips, Yellow	MCCMV9YL10

Online Resources

Brochure
Customer Drawing
Customer Use Drawing
eCatalog

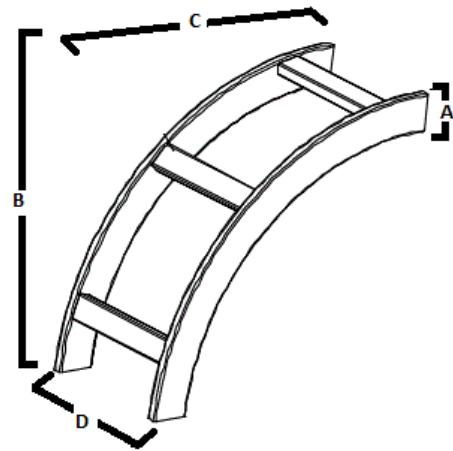

Dimensions- inches (mm)

A	1.5" (38)
B	11.5" (292)
C	11.5" (292)
D	6" (152)