

HLS Ladder Tray Tray Section

HUBBELL

Triangle Wall Support Bracket

Features

- HLS Ladder Tray is a modular system that is easily configured for all unique installations
- Ladder tray sections universally work with all ladder tray accessories
- HLS Ladder feature rung spacing every 9" to support and relieve cable stress

Ordering Information

Color	Width	Catalog Number	UPC Number
Black	18"	HLTSB18B	662620819785

Specifications

Material	Steel
Finish	Black
Installation	Mounts to Wall

Accessories

Ladder Splice Kit	HLBSK
Protective End Caps	HLCEPK2
Black Velcro Roll	HVFBK575
9" Velcro Strips, Yellow	MCCMV9YL10

Online Resources

Brochure
Customer Drawing
Customer Use Drawing
eCatalog

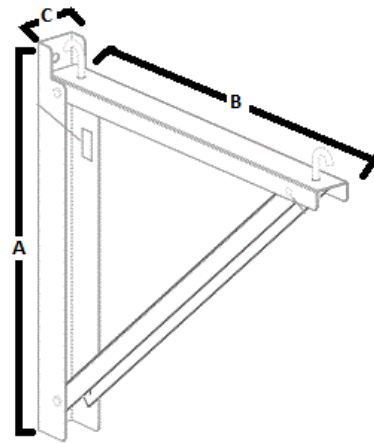

Dimensions- inches (mm)

A	19" (483)
B	19" (483)
C	0.89" (23)