

Mounted Zone Cabling Enclosures and Brackets

Wall Mounted Enclosure

QuadCab Enclosure, 36" depth

HUBBELL

Features

- Modular construction with mid-section to swing out to access rear installed equipment
- Modular backboard systems eliminates field engineering
- Distributing network equipment lessens heat load in the telecom room

Ordering Information

Height	Door Style	Catalog Number	UPC Number
36"	Acrylic Window	HSQ3636	662620853406

Listings

EIA/ECA-310-E Universal Mounting Pattern

Specifications

Material	Cold rolled steel
Rear & Middle Gauge	14
Door Gauge	18
Door Type	Window
Rail Type	#12-24 Threaded
Finish	Black powder coat

Characteristics

Access	Swing out center section
Load Capacity	408 lb
Rack Units	19

Accessories

1U Power strip	HPWPWR
1U Horizontal cable manager with cover	HM14C
2U Horizontal cable manager with cover	HM24C
Mobile Base	HSQKMB36

Online Resources

Customer Drawing
Customer Use Drawing
eCatalog

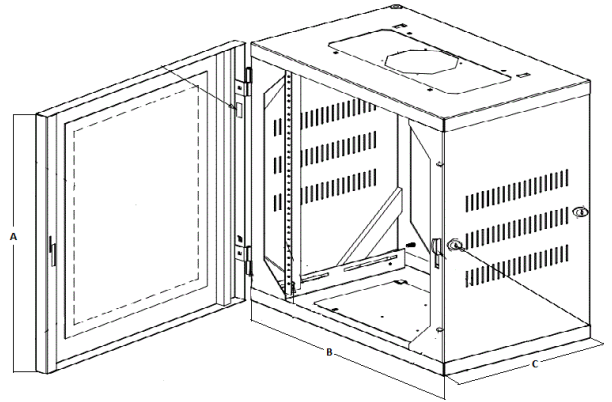

Dimensions- inches (mm)

A	36.4" (925)
B	22.6" (574)
C	36.3" (922)