

# Mounted Zone Cabling Enclosures and Brackets

## Wall Mounted Enclosure

### QuadCab Enclosure, 36" depth

# HUBBELL

#### Features

- Modular construction with mid-section to swing out to access rear installed equipment
- Modular backboard systems eliminates field engineering
- Distributing network equipment lessens heat load in the telecom room

#### Ordering Information

Height	Door Style	Catalog Number	UPC Number
36"	Solid Door	HSQ36S36	662620853468

#### Listings

EIA/ECA-310-E Universal Mounting Pattern

#### Specifications

Material	Cold rolled steel
Rear & Middle Gauge	14
Door Gauge	18
Door Type	Solid
Rail Type	#12-24 Threaded
Finish	Black powder coat

#### Characteristics

Access	Swing out center section
Load Capacity	411 lb
Rack Units	19

#### Accessories

1U Power strip	HPWPWR
1U Horizontal cable manager with cover	HM14C
2U Horizontal cable manager with cover	HM24C
Mobile Base	HSQKMB36

#### Online Resources

Customer Drawing  
Customer Use Drawing  
eCatalog

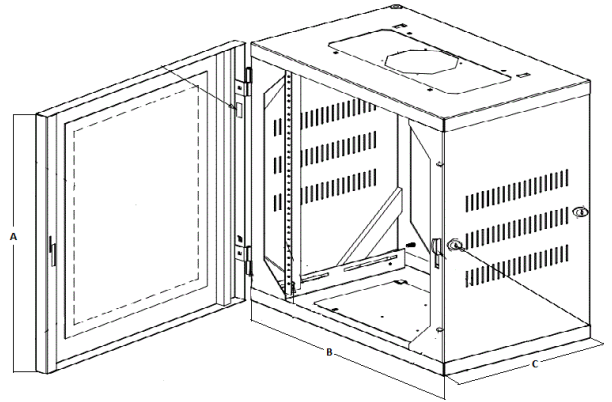

#### Dimensions- inches (mm)

A	36.4" (925)
B	22.6" (574)
C	36.3" (922)