

Cable Management Vertical Cable Manager Accessory S-Series Accessory

HUBBELL

Features

- Gates clip into place to constrain cable and provide ample support
- Steel construction provides ample strength for heavy cable loading



Ordering Information

Width	Uses Series	Catalog Number	UPC
8"	VS & VM	VCG8	662620248646

Specifications

Material	Steel
Gauge	14
Finish	Black Powder Coated

Characteristics

Installation	Clip into place
Corresponding Vertical Cbl Mgr	VM Series

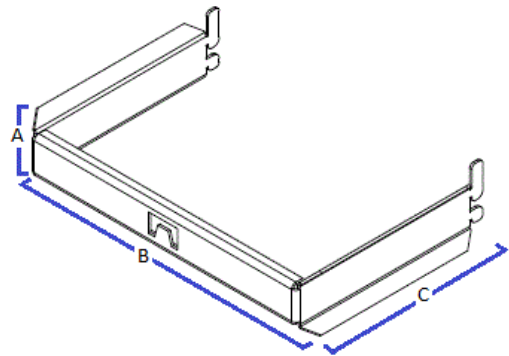

Accessories

Black Velcro Roll	HVFBK575
9" Velco Strips, Yellow	MCCMV9YL10

Dimensions- inches (mm)

A	1.25" (32)
B	8" (203)
C	3.25" (83)

Online Resources

[eCatalog](#)