

RSA-B-DBE-S SERIES POLES

ROUND STRAIGHT ALUMINUM

Cat.#

Job

Type



Approvals

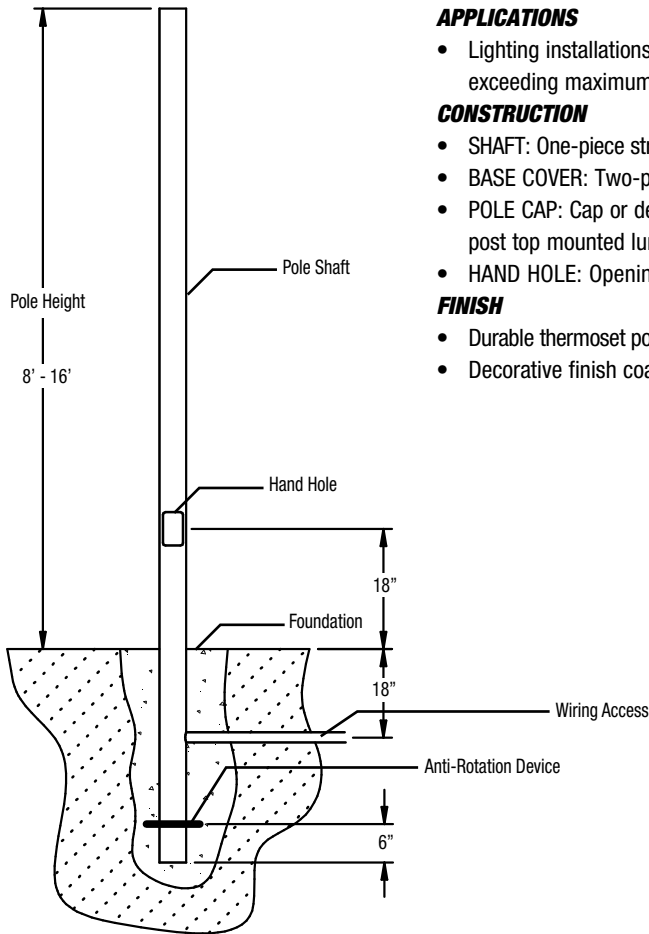

APPLICATIONS

- Lighting installations for side and top mounting of luminaires with effective projected area (EPA) not exceeding maximum allowable loading of the specified pole in its installed geographic location

CONSTRUCTION

- SHAFT: One-piece straight aluminum with round cross section, 6061-T6
- BASE COVER: Two-piece cast aluminum base covers available
- POLE CAP: Cap or decorative finials available for side mounted luminaires. Open top or tenons provided for post top mounted luminaires.
- HAND HOLE: Opening provided with cast aluminum frame reinforcement.

FINISH

- Durable thermoset polyester powder coat paint finish with nominal 3.0 mil thickness
- Decorative finish coat available in twelve standard colors; Custom colors available; RAL number preferable

TENONS & POLE CAPS

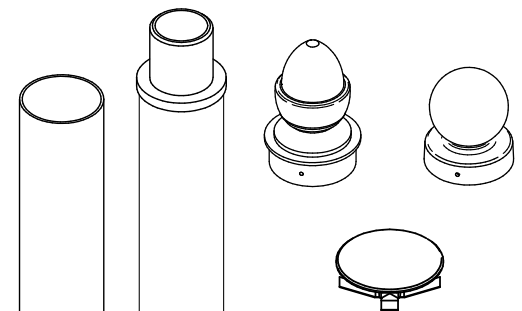

*Local civil engineer should be consulted for proper foundation design

ORDERING EXAMPLE:

RSA-B-DBE-S - 16 - 40 - A/B/C - CAP - 2L - B3 - BBT - VM2

SERIES	HEIGHT	SHAFT	THICKNESS	MOUNTING	FINISH	OPTIONS
RSA-B-DBE-S Round Straight Aluminum Direct Burial Style Beacon Smooth	Reference page 2 Ordering matrix	Reference page 2 Ordering matrix	Reference page 2 Ordering matrix	1 Single arm mount 2 Two fixtures at 180° 2L² Two fixtures at 90° 3T² Three fixtures at 90° 3Y² Three fixtures at 120° 4² Four fixtures at 90° OT³ Open top (no drilling) BAL³ Ball Finial ARC³ Acorn Finial CAP³ Cap Top TN3³ Tenon 3 x 3 TN4³ Tenon 3 x 4 TN5³ Tenon 4 x 5 TN8³ Tenon 4 x 8	BLT Black Matte Textured BLS Black Gloss Smooth DBT Dark Bronze Matte Textured DBS Dark Bronze Gloss Smooth GTT Graphite Matte Textured LGS Light Grey Gloss Smooth PSS Platinum Silver Smooth WHT White Matte Textured WHS White Gloss Smooth VGT Verde Green Textured Color Option CC Custom Color	GFI^{1,2} 20 Amp GFCI Receptacle and Cover EHH^{1,2} Extra Handhole C05¹ .5" Coupling C07¹ .75" Coupling C20¹ 2" Coupling VM2 2nd mode vibration damper

MOUNTING ORIENTATION

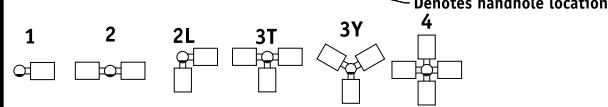

1 Specify option location using logic found on page 2 (Option Orientation)
 2 Not available with 3" diameter poles.
 3 Specify Pole Top

ACCESSORIES- Order Separately

Catalog Number	Description
VM2SXX	2nd mode vibration damper

DRILL PATTERN

- B1** Cruiser, "AM" arm
- B3** 2 bolt (2-1/2" spacing), Viper "A" arm
- S2** 2 bolt (3-1/2" spacing), Viper "AD" arm



ORDERING INFORMATION Cont.

Catalog Number	Pole Height		Nominal Shaft Dimensions	Wall Thickness	Pole weight (lbs)
	Feet	Meters			
RSA-B-DBE-S-08-40-A	08	2.4	4" Round	0.125"	20
RSA-B-DBE-S-10-40-A	10	3.0	4" Round	0.125"	24
RSA-B-DBE-S-12-40-A	12	3.7	4" Round	0.125"	29
RSA-B-DBE-S-14-40-A	14	4.3	4" Round	0.125"	34
RSA-B-DBE-S-16-40-A	16	4.9	4" Round	0.125"	39
RSA-B-DBE-S-08-40-B	08	2.4	4" Round	0.188"	29
RSA-B-DBE-S-10-40-B	10	3.0	4" Round	0.188"	36
RSA-B-DBE-S-12-40-B	12	3.7	4" Round	0.188"	43
RSA-B-DBE-S-14-40-B	14	4.3	4" Round	0.188"	50
RSA-B-DBE-S-16-40-B	16	4.9	4" Round	0.188"	57
RSA-B-DBE-S-08-40-C	08	2.4	4" Round	0.25"	37
RSA-B-DBE-S-10-40-C	10	3.0	4" Round	0.25"	47
RSA-B-DBE-S-12-40-C	12	3.7	4" Round	0.25"	56
RSA-B-DBE-S-14-40-C	14	4.3	4" Round	0.25"	65
RSA-B-DBE-S-16-40-C	16	4.9	4" Round	0.25"	74
RSA-B-DBE-S-08-50-B	08	2.4	5" Round	0.188"	36
RSA-B-DBE-S-10-50-B	10	3.0	5" Round	0.188"	45
RSA-B-DBE-S-12-50-B	12	3.7	5" Round	0.188"	54
RSA-B-DBE-S-14-50-B	14	4.3	5" Round	0.188"	63
RSA-B-DBE-S-16-50-B	16	4.9	5" Round	0.188"	71
RSA-B-DBE-S-10-60-A	10	3.0	6" Round	0.125"	37
RSA-B-DBE-S-12-60-A	12	3.7	6" Round	0.125"	44
RSA-B-DBE-S-14-60-A	14	4.3	6" Round	0.125"	51
RSA-B-DBE-S-16-60-A	16	4.9	6" Round	0.125"	58

EHH - EXTRA HANDHOLE

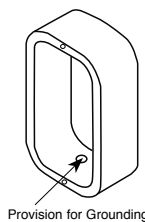

Provision for Grounding

C05 - C07 - C20 - COUPLING

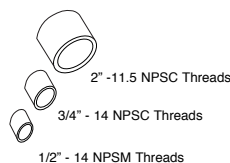

2" - 11.5 NPSC Threads

3/4" - 14 NPSM Threads

1/2" - 14 NPSM Threads

VM2SXX - VIBRATION DAMPER 2ND MODE



Field installed, internal damper designed to alter pole resonance to reduce movement and material fatigue caused by 2nd mode vibration.

VM2S08 - 8'
VM2S12 - 12'
VM2S16 - 16'
VM2S20 - 20'
VM2S24 - 24'

VM2 - VIBRATION DAMPER 2ND MODE



Factory installed, internal damper designed to alter pole resonance to reduce movement and material fatigue caused by 2nd mode vibration.

GFI - 20 AMP GFCI RECEPTACLE & COVER

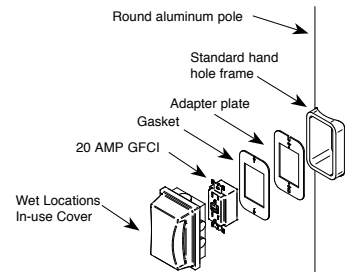

OPTION ORIENTATION

Follow the logic below when ordering location specific options. For each option, include its orientation (in degrees) and its height (in feet). Example: Option C07 should be ordered as: **RSA-B-DBE-S-16-40A-TN3-DBT-C05-0-10**. (.5" coupling on the handhole/arm side of pole, 10 feet up from the pole base) 1' spacing required between option. Consult factory for other configurations.

For more information about pole vibration and vibration dampers, please consult http://cdn.beaconproducts.com/content/products/literature/literature_files/Pole_Wind_Induced_Flyer_HL010022.pdf
Due to our continued efforts to improve our products, product specifications are subject to change without notice.



Beacon Products • 701 Millennium Blvd, Greenville, SC 29607 • Phone: 864-678-1000

Due to our continued efforts to improve our products, product specifications are subject to change without notice.

© 2020 BEACON PRODUCTS, All Rights Reserved • For more information visit our website: www.beaconproducts.com • Printed in USA



RSA-B-DBE-S POLES-SPEC JULY 28, 2020 10:29 AM

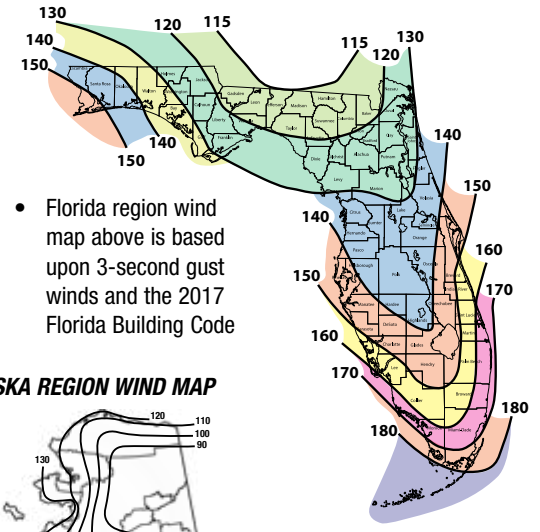
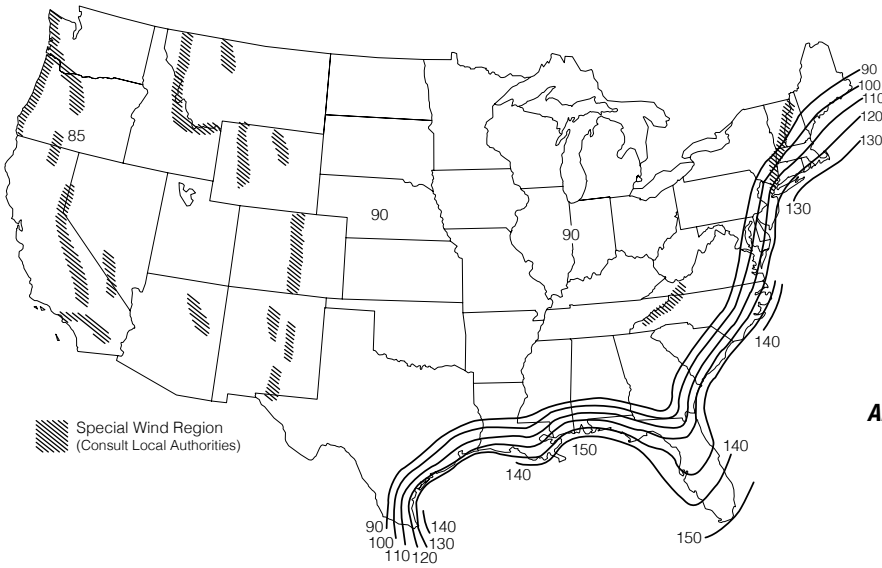

• Florida region wind map above is based upon 3-second gust winds and the 2017 Florida Building Code

ALASKA REGION WIND MAP

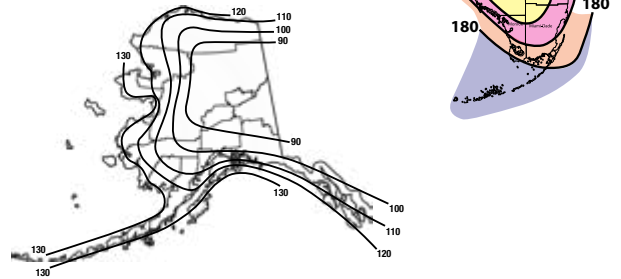

HAWAII – 105 mph
PUERTO RICO – 145 mph

*PRINTED WITH PERMISSION FROM ASCE

ASCE 7-05 wind map EPA Load Rating - 3 second gust wind speeds										
Catalog Number	85	90	100	105	110	120	130	140	145	150
RSA-B-DBE-S-08-40-A	21.8	19.5	15.8	14.3	13.0	10.9	9.3	8.0	7.4	6.9
RSA-B-DBE-S-10-40-A	16.5	14.8	11.9	10.7	9.7	8.0	6.8	5.9	5.4	5.1
RSA-B-DBE-S-12-40-A	12.9	11.5	9.2	8.2	7.4	6.0	5.1	4.3	4.0	3.7
RSA-B-DBE-S-14-40-A	10.3	9.1	7.1	6.3	5.6	4.5	3.7	3.2	2.9	2.7
RSA-B-DBE-S-16-40-A	8.2	7.2	5.5	4.8	4.3	3.3	2.7	2.2	2.0	1.8
RSA-B-DBE-S-08-40-B	25.0	25.0	23.2	21.1	19.2	16.1	13.8	11.9	11.1	10.4
RSA-B-DBE-S-10-40-B	24.3	21.8	17.7	16.0	14.5	12.1	10.4	8.9	8.3	7.8
RSA-B-DBE-S-12-40-B	19.2	17.2	13.9	12.5	11.3	9.4	8.0	6.9	6.4	5.9
RSA-B-DBE-S-14-40-B	15.5	13.8	11.1	10.0	9.0	7.3	6.2	5.3	4.9	4.6
RSA-B-DBE-S-16-40-B	12.7	11.3	8.9	8.0	7.1	5.7	4.8	4.1	3.8	3.5
RSA-B-DBE-S-08-40-C	25.0	25.0	25.0	25.0	24.7	20.8	17.8	15.4	14.4	13.4
RSA-B-DBE-S-10-40-C	25.0	25.0	22.9	20.8	18.9	15.9	13.6	11.7	10.9	10.2
RSA-B-DBE-S-12-40-C	24.9	22.3	18.2	16.4	14.9	12.5	10.6	9.2	8.5	8.0
RSA-B-DBE-S-14-40-C	20.3	18.2	14.7	13.3	12.0	9.9	8.4	7.3	6.7	6.3
RSA-B-DBE-S-16-40-C	16.8	15.0	12.0	10.8	9.7	8.0	6.7	5.8	5.3	5.0
RSA-B-DBE-S-08-50-B	25.0	25.0	25.0	25.0	25.0	23.2	20.1	18.7	17.5	17.5
RSA-B-DBE-S-10-50-B	25.0	25.0	25.0	25.0	24.8	21.0	17.9	15.5	14.5	13.5
RSA-B-DBE-S-12-50-B	25.0	25.0	23.8	21.7	19.9	16.8	14.3	12.4	11.5	10.8
RSA-B-DBE-S-14-50-B	25.0	23.8	19.4	17.7	16.2	13.7	11.6	10.0	9.3	8.7
RSA-B-DBE-S-16-50-B	22.2	19.8	16.1	14.6	13.4	11.2	9.6	8.2	7.6	7.1
RSA-B-DBE-S-10060-A	25.0	25.0	25.0	25.0	25.0	21.4	18.2	15.8	14.7	13.7
RSA-B-DBE-S-12060-A	25.0	25.0	24.4	22.2	20.3	17.1	14.6	12.6	11.8	11.0
RSA-B-DBE-S-14060-A	25.0	24.4	20.0	18.2	16.6	14.0	12.0	10.3	9.6	8.9
RSA-B-DBE-S-16060-A	22.7	20.4	16.6	15.1	13.8	11.6	9.9	8.5	7.9	7.3

Florida Building Code 2017 EPA Load Rating - 3 second gust wind speeds								
Catalog Number	115	120	130	140	150	160	170	180
RSA-B-DBE-S-08-40-A	21.2	19.6	16.7	14.4	12.4	10.8	10.1	9.0
RSA-B-DBE-S-10-40-A	16.0	14.7	12.5	10.7	9.2	7.9	7.6	6.7
RSA-B-DBE-S-12-40-A	12.5	11.4	9.6	8.1	6.9	5.8	5.6	5.1
RSA-B-DBE-S-14-40-A	9.8	8.9	7.4	6.2	5.1	4.2	4.0	3.9
RSA-B-DBE-S-16-40-A	7.7	7.0	5.7	4.6	3.7	2.9	2.5	2.0
RSA-B-DBE-S-08-40-B	25.0	25.0	24.6	21.3	18.5	16.2	14.9	13.3
RSA-B-DBE-S-10-40-B	23.8	21.9	18.7	16.1	14.0	12.1	11.4	10.1
RSA-B-DBE-S-12-40-B	18.8	17.3	14.7	12.6	10.8	9.3	9.0	7.9
RSA-B-DBE-S-14-40-B	15.1	13.9	11.7	9.9	8.5	7.2	6.7	6.3
RSA-B-DBE-S-16-40-B	12.2	11.1	9.3	7.8	6.5	5.5	5.2	5.0
RSA-B-DBE-S-08-40-C	25.0	25.0	25.0	25.0	23.9	21.0	19.2	17.1
RSA-B-DBE-S-10-40-C	25.0	25.0	24.3	21.0	18.2	15.9	14.8	13.2
RSA-B-DBE-S-12-40-C	24.4	22.5	19.2	16.5	14.3	12.4	11.8	10.4
RSA-B-DBE-S-14-40-C	19.8	18.3	15.6	13.3	11.4	9.8	9.6	8.4
RSA-B-DBE-S-16-40-C	16.2	14.9	12.6	10.7	9.1	7.7	7.1	6.8
RSA-B-DBE-S-08-50-B	25.0	25.0	25.0	25.0	25.0	25.0	24.4	21.8
RSA-B-DBE-S-10-50-B	25.0	25.0	25.0	25.0	24.3	21.4	18.9	16.8
RSA-B-DBE-S-12-50-B	25.0	25.0	24.9	22.5	19.6	17.2	15.1	13.4
RSA-B-DBE-S-14-50-B	25.0	23.8	20.2	18.6	16.1	14.1	12.4	10.9
RSA-B-DBE-S-16-50-B	21.3	19.5	16.4	15.4	13.3	11.6	10.1	8.8
RSA-B-DBE-S-10060-A	25.0	25.0	25.0	25.0	24.4	21.4	18.9	16.7
RSA-B-DBE-S-12060-A	25.0	25.0	25.0	22.6	19.6	17.1	15.0	13.3
RSA-B-DBE-S-14060-A	25.0	25.0	21.6	18.6	16.1	14.0	12.2	10.7
RSA-B-DBE-S-16060-A	22.9	21.1	17.9	15.3	13.2	11.4	9.9	8.6

NOTES

Wind-speed Website disclaimer:

Hubbell Lighting has no connection to the linked website and makes no representations as to its accuracy. While the information presented on this third-party website provides a useful starting point for analyzing wind conditions, Hubbell Lighting has not verified any of the information on this third party website and assumes no responsibility or liability for its accuracy. The material presented in the windspeed website should not be used or relied upon for any specific application without competent examination and verification of its accuracy, suitability and applicability by engineers or other licensed professionals. Hubbell Lighting Inc. does not intend that the use of this information replace the sound judgment of such competent professionals, having experience and knowledge in the field of practice, nor to substitute for the standard of care required of such professionals in interpreting and applying the results of the windspeed report provided by this website. Users of the information from this third party website assume all liability arising from such use. Use of the output of these referenced websites do not imply approval by the governing building code bodies responsible for building code approval and interpretation for the building site described by latitude/longitude location in the windspeed report. <http://windspeed.atcouncil.org>

- Allowable EPA, to determine max pole loading weight, multiply allowable EPA by 30 lbs.
- The tables for allowable pole EPA are based on the ASCE 7-05 Wind Map or the Florida Region Wind Map for the 2010 Florida Building Code. The Wind Maps are intended only as a general guide and cannot be used in conjunction with other maps. Always consult local authorities to determine maximum wind velocities, gusting and unique wind conditions for each specific application
- Allowable pole EPA for jobsite wind conditions must be equal to or greater than the total EPA for fixtures, arms, and accessories to be assembled to the pole. Responsibility lies with the specifier for correct pole selection. Installation of poles without luminaires or attachment of any unauthorized accessories to poles is discouraged and shall void the manufacturer's warranty
- Wind speeds and listed EPAs are for ground mounted installations. Poles mounted on structures (such as bridges and buildings) must consider vibration and coefficient of height factors beyond this general guide; Consult local and federal standards
- Wind Induced Vibration brought on by steady, unidirectional winds and other unpredictable aerodynamic forces are not included in wind velocity ratings. Consult Hubbell Lighting's Pole Vibration Application Guide for environmental risk factors and design considerations. http://cdn.beaconproducts.com/content/products/literature/literature_files/Pole_Wind_Induced_Flyer_HLOI0022.pdf
- Extreme Wind Events like, Hurricanes, Typhoons, Cyclones, or Tornadoes may expose poles to flying debris, wind shear or other detrimental effects not included in wind velocity ratings

Due to our continued efforts to improve our products, product specifications are subject to change without notice.

