

UCC-D08

by CMC
Catalog ID: UCC-D08

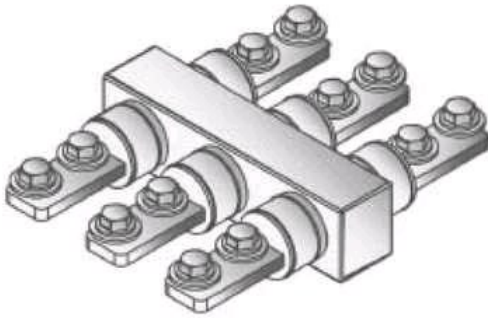

Submersible Connector for Direct Burial, Below-Grade Boxes, and Network Underground. For Use with Copper Compression Lugs.

- Connects copper conductors through 1000 kcmil with two-hole NEMA compression lugs.
- C3
- Committee Guide 2.5.
- Stainless steel mounting hardware included.
- Boots are watertight EPDM rubber.
- Repairs 350 kcmil down to #10 wire sizes.
- For installation CMC® recommends the use of a 9" insulated Allen wrench.
- A torque wrnch should be used to ensure the proper torque is achieved.
- TH Sleeves (sold separately) allow for a waterproof seal up to 1000 kcmil.
- Ceneterform compression lugs available in common 500, 750 and 1000 mcm.

Product Details

General

Material	Copper, Tin Plated
Number Of Outlets	8
UPC	192663116805

Dimensions

Length	12 in
Width	11 in