

Pulling Grips

Features

- Galvanized steel mesh provides high strength
- High strength multiweave mesh for positive holding power
- Highly flexible mesh to follow the pulling path of the cable

Ordering Information

Description	Eye Type	Cable	UPC	Catalog Number
Double/Single Weave Mesh for Outside Plant Cable	Swivel Eye	.64"-.87" (1.63-2.21)	783585332901	033291012

Listings

CSA Certified

Specifications

Strand	Galvanized Steel
Eye	Steel
Sleeve	Aluminum
Fastener	Plastic
Tag	Mylar

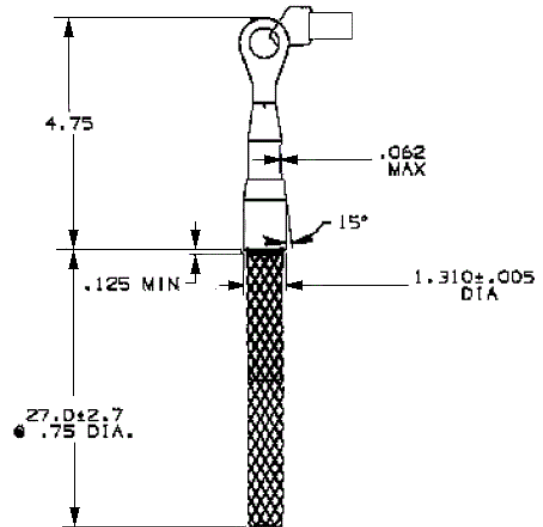

Online Resources

Customer Sales Drawings
eCatalog

IMPORTANT

Please review all SAFETY INFORMATION for grips on the following page.

Dimensions in Inches (mm)

Hubbell Wiring Device-Kellems • Hubbell Incorporated (Delaware) • 40 Waterview Drive • Shelton, CT 06484

Phone (800) 288-6000 • Fax (800) 255-1031 • Specifications subject to change without notice.

Fiber Optic Grip Safety Information

Kellems has wide experience with grips for use with fiber optic cable. As the industry leader in producing wire mesh grips for the stringent requirements of fiber optic applications, Kellems has developed several series of grips for use with fiber optic communications cable.

These grips include pulling grips with built in swivels, grips with steel ends to protect fragile cable ends, grips with low profiles to pull cables in tight places and the OPTISOK® an effective tool to place preterminated cables. Also available are grips to support fiber optic cable.

Select The Correct Grip

Each Kellems Grip is designed to work on a specific range of cable diameters.

Step 1 Determine your cable outside diameter.

Step 2 Find the grip size that encompasses your cable diameter.

Step 3 Whenever possible, use a closed mesh that assembles over the cable end. If the cable end is not available, use a split mesh.

Step 4 Where available, select an eye style that suits your needs.

Step 5 Estimate the tension to be put on the grip, establish the working load you require and compare this to the listed approximate breaking strength of the grip to insure that the grip will be strong enough.

Safety And Working Load Factors For Fiber Optic Grips

The broad application of Kellems grips on a wide variety of objects requires that adequate safety factors be used to establish working loads. The approximate breaking strength of a Kellems grip represents an average calculation based on data established from actual direct tension testing done in our engineering laboratories.

It is impossible to catalog or guarantee a safety factor suitable for all applications as operating conditions are never the same. The tension, diameter, movement, number of objects gripped, gripping surface, and the attachments used are just some of the factors which vary with each application. These factors, together with the effects of abrasion, corrosion, prior use or abuse and any other variables of a specific application, must be considered by the user and the grip replaced as

appropriate. Where the conditions of the application are not well defined or known, or where risk of injury to persons or property is involved, a greater safety factor should be utilized.

Under normal conditions, Kellems' recommended factor of safety is five for fiber cable pulling grips, and ten for fiber cable support grips.

Any warranty as to quality, performance or fitness for use of grips is always premised on the condition that the published breaking strengths apply only to new, unused grips, and that such products are properly stored, handled, used, maintained and inspected by the user at a frequency appropriate for the use and condition of the grip.