

Kellems® Wire Management Products  
 Strain Relief for Liquidtight Conduit  
 Liquidtight Conduit Grips

# HUBBELL

## Features

- Helps prevent conduit pull-out and damage at fitting
- Reduces equipment downtime

## Ordering Information

Description	Style	UPC	Catalog Number
Liquidtight Conduit, 45° Angle With Male Fitting	45 Degree	783585332109	074093564



## Listings

UL Listed  
 CSA Certified

## Specifications

Strand	Stainless Steel
Body	Zinc plated steel
Seal	Nylon
Ferrule	Zinc plated steel
Locknut	Zinc plated steel
Insulator	Nylon

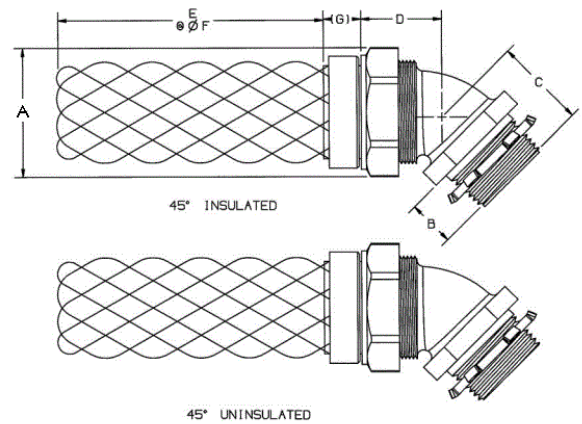

## Performance

### Environmental

Flammability	UL 94-HB and UL 94-V2
Hazardous Location	Suitable for use in hazardous locations per Class I, Div. 2, Class II, Div. 1 & 2, Class III, Div. 1 & 2
Operating Temperature	-30°F to +225°F (-34°C to +107°C)

## Online Resources

Customer Use Drawing  
 eCatalog

Dimensions in Inches (mm)

Hubbell Wiring Device-Kellems • Hubbell Incorporated (Delaware) • 40 Waterview Drive • Shelton, CT 06484

Phone (800) 288-6000 • Fax (800) 255-1031 • Specifications subject to change without notice.

