

## Floor Boxes

### SystemOne Recessed 2 Gang Floor Box Cover

For Use In Raised Access and Wood Floors

# HUBBELL

#### Features

- 180 degree cover opening to lay flat and reduce tripping hazards
- Two large cable egress doors
- Die cast aluminum cover construction for enhanced durability
- ADA Compliant

#### Ordering Information

- Compatible with AFB2G25 and AFB2G50
- Rectangular style typical applications: Raised Floors, Wood Floors

<b>Catalog Number</b> 2GAFBCVRBRZ	<b>UPC Number</b> 783585526874	<b>Style</b> Raised Access / Wood	<b>Finish</b> Antique Bronze Powder Coat
<b>Dimensions</b> 8-3/4 x 14-15/16 in.	<b>Floor Finish Insert</b> No		

#### Specifications

Cover Material	Aluminum
Flange height	0.25 in.
Adjustment Range	0 - 1.0 inch
Load Rating	800 lbs. (w/ 2x safety factor)

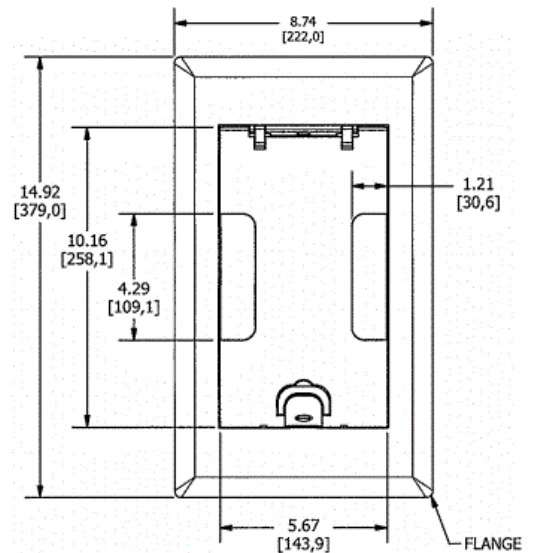

#### Online Resources

[Customer Use Drawing](#)  
[eCatalog](#)  
[Installation Instructions](#)

Dimensions in Inches (mm)

Hubbell Wiring Device-Kellems • Hubbell Incorporated (Delaware) • 40 Waterview Drive • Shelton, CT 06484

Phone (800) 288-6000 • Fax (800) 255-1031 • Specifications subject to change without notice.

