

Straight Blade Devices
 15A, 125V, 2 Pole, 3 Wire Grounding
 Hubbell-Pro™ Heavy Duty Duplex
 Receptacles

HUBBELL

Features

- Triangle marking on face indicates isolated ground
- Slender/compact design
- Finder Groove Face

Ordering Information

Description	Device Color	UPC	Catalog Number
Isolated ground, back and side wired.	Ivory	783585387048	CR5252IGI

Listings

UL Listed to UL498 File No. E2186
 Certified to CSA, C22.2, No. 42 File 285
 Fed. Spec. WC596
 NEMA® WD-6 Compliant

Specifications

Face	Nylon
Base	PBT
Mounting Strap	.040" (1) Galvanized steel
Ground Contacts	.031" (.8) Brass
Clamp	Nickel plated steel
Terminal Screws	Brass
Mounting Strap	Galvanized steel
Automatic Self-grounding Clip	Stainless steel
Mounting Screws	Stainless Steel

Performance

Electrical	
Current Interrupting	Certified for current interrupting at full rated current
Dielectric Voltage	Withstands 2,000V minimum
Mechanical	
Product Identification	Ratings are a permanent part of the device
Terminal Accommodation	#14-#10 AWG copper stranded or solid conductor only
Terminal Identification	Terminals identified in accordance with UL 498 and CSA

Environmental	
Flammability	UL 94 V-2
Operating Temperatures	Maximum continuous 75°C; minimum -40°C (w/o impact)

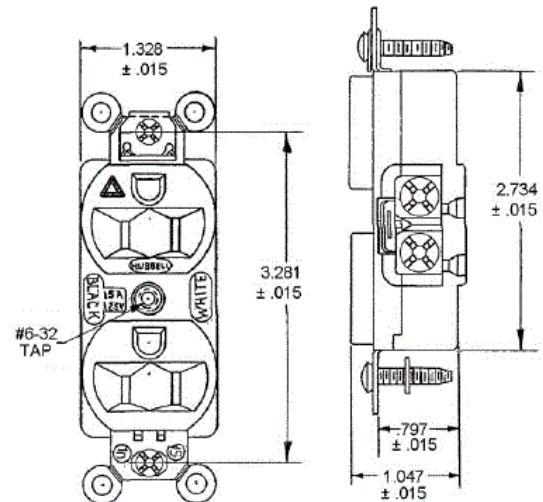

Accessories

Wallplate or Weatherproof Cover Duplex Opening

Resources

Customer Use Drawing
 eCatalog

Dimensions in Inches (mm)

Hubbell Wiring Device-Kellems • Hubbell Incorporated (Delaware) • 40 Waterview Drive • Shelton, CT 06484

Phone (800) 288-6000 • Fax (800) 255-1031 • Specifications subject to change without notice.

