

Switches, Three Way
20A, 120-277V AC
Pre-Wired Style Line® Decorator Series
Specification Grade Switch

HUBBELL

Features

- Labor Saving
- Thread cleaning captive mounting screw
- Steel, zinc plated bridge is corrosion resistant

Ordering Information

Description	Rocker Color	UPC	Catalog Number
Rocker, Polycarbonate, Pre-wired leads	White	783585187082	DSL320W

Listings

UL Listed
CSA Certified

Specifications

Contacts	Silver Alloy
Terminal Screws	Brass
Rocker Material	Thermoplastic
Mounting Bridge	Nickel Plated Steel with Auto Ground Staple
Contacts	Silver Alloy
Ground Screw	Brass (Green)

Performance

Electrical

Dielectric Voltage	Withstands 1500V AC minimum for 1 minute
Max. Continuous Current	20A
Max. Working Voltage	277V AC
Overload	Minimum 4.8 times rated current for 100 cycles
Temperature Rise	30°C maximum at rated current

Mechanical

Terminal Accommodations 8" #12 AWG THHN

Environmental

Flammability	UL 94V-2
Operating Temperature	Max. continuous: 75°C; Min. continuous: -40°C without impact

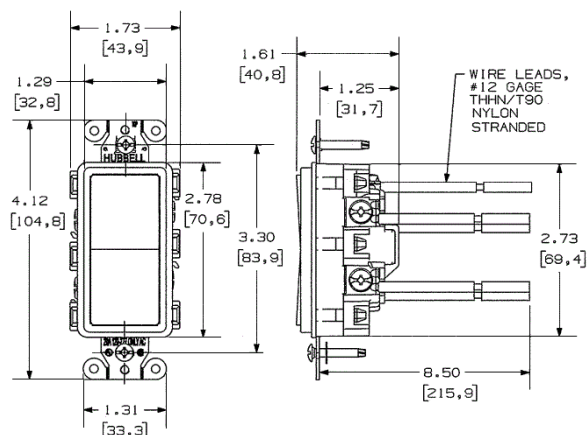

Online Resources

Customer Use Drawing
eCatalog
Installation Instructions

Dimensions in Inches (mm)

Hubbell Wiring Device-Kellems • Hubbell Incorporated (Delaware) • 40 Waterview Drive • Shelton, CT 06484

Phone (800) 288-6000 • Fax (800) 255-1031 • Specifications subject to change without notice.

