

## Features

- Patented shutter design for tamper-resistant
- Compliant with NEC® 406.12 and NEC® 517-18(c)
- Patented AUTOGUARD® self test technology
- Triple wipe construction

## Ordering Information

Description	Color	UPC	Catalog Number
15A, 125V, Style Line®, AUTOGUARD® self test GFCI receptacle, tamper-resistant, flush face, back and side wired, multiple drive screws	Red	883778122309	GFTRST15R



## Listings

UL Listed - Canadian and U.S.  
Meets ADA Standards  
Meets all NEC® requirements  
CSA Certified  
NEMA® WD-6 Compliant

## Specifications

Face	Nylon
Base	Nylon
Power Contacts	Brass
Ground Contacts	Brass
Mounting Strap	Zinc plated steel
Mounting Screws	Zinc plated steel

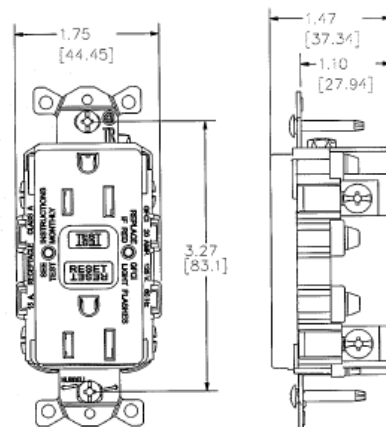

## Online Resources

Customer Use Drawing  
eCatalog  
Installation Instructions