

Ground Fault Products
Commercial Tamper-Resistant and Weather
Resistant GFCI Receptacles

HUBBELL

Features

- Audible SNAP, indicates solid connection
- Patented shutter design for tamper-resistant protection
- Meets NEC requirements for TR (517-18c) and WR (406.9), UV and corrosion resistance for harsh and damp applications
- Patented AUTOGUARD® self test technology
- Protects against line and load reversal, no power to the face or downstream if device is miswired

Ordering Information

Description	Color	UPC	Catalog Number
20A, 125V, Style Line®, hospital grade, SNAPConnect®, AUTOGUARD® self test GFCI receptacle, tamper-resistant and weather resistant, flush face, back and side wired, multiple drive screws	Almond	783585486468	GFTWRST83SNAPAL

Listings

UL Listed - Canadian and U.S.
Meets ADA Standards
Meets all NEC® requirements
CSA Certified
NEMA® WD-6 Compliant

Specifications

Face	Nylon
Base	Nylon
Power Contacts	Brass
Ground Contacts	Brass
Mounting Strap	Brass
Mounting Screws	Zinc plated steel

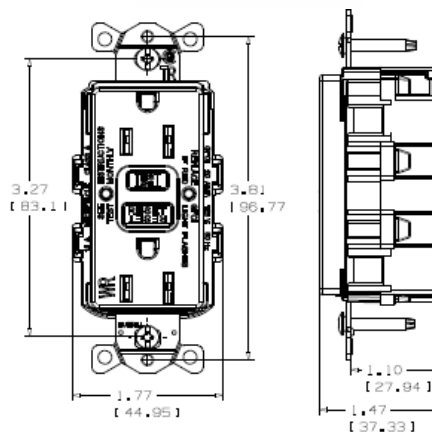

Complementary Products

Wallplates for duplex openings SNAP1RA	Solid Right Angle Pigtailed Terminal Stranded Right Angle Pigtailed Terminal
---	--

Online Resources

Customer Use Drawing
eCatalog
Installation Instructions

Dimensions in Inches (mm)

Hubbell Wiring Device-Kellems • Hubbell Incorporated (Delaware) • 40 Waterview Drive • Shelton, CT 06484

Phone (800) 288-6000 • Fax (800) 255-1031 • Specifications subject to change without notice.

