

Kellems® Wire Management Products  
Metallic Liquidtight Conduit Fittings  
Conduit Fitting

# HUBBELL

## Features

- Hexagonal nut compresses gland-ring onto conduit
- Nylon gasket provides liquidtight seal at hub
- Non-integral steel ferrule seals conduit

## Ordering Information

Description	Trade Size	UPC	Catalog Number
90° Conduit Fitting, Insulated	1 1/2" (41)	783585035468	H15091



## Listings

UL Listed  
CSA Certified

## Specifications

Fitting	Zinc plated iron
Compression Nut	Zinc plated iron
Ferrule	Zinc plated steel
Split Seal Ring	Nylon
Washer	Nylon
Locknut	Zinc plated steel
Insulator	Nylon

## Performance

Environmental	
Operating Temperature	-60°F to +1000°F (-51°C to +538°C)

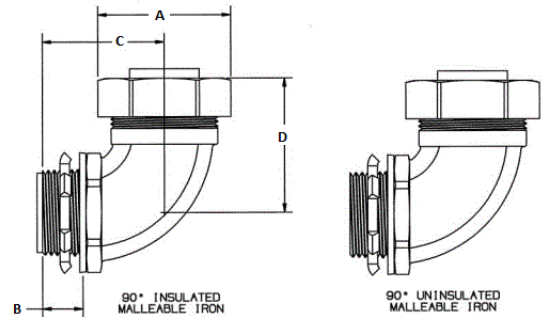

## Online Resources

Customer Use Drawing  
eCatalog  
Installation Instructions

Dimensions in Inches (mm)

Hubbell Wiring Device-Kellems • Hubbell Incorporated (Delaware) • 40 Waterview Drive • Shelton, CT 06484

Phone (800) 288-6000 • Fax (800) 255-1031 • Specifications subject to change without notice.

