

Kellems® Wire Management Products
 Metallic Liquidtight Conduit Fittings
 Conduit Fitting

HUBBELL

Features

- Hexagonal nut compresses gland-ring onto conduit
- Nylon gasket provides liquidtight seal at hub
- Non-integral steel ferrule seals conduit

Ordering Information

Description	Trade Size	UPC	Catalog Number
90° Conduit Fitting, Non-Insulated	2 1/2" (63)	783585034188	H2509



Listings

UL Listed
 CSA Certified

Specifications

Fitting	Zinc plated iron
Compression Nut	Zinc plated iron
Ferrule	Zinc plated steel
Split Seal Ring	Nylon
Washer	Nylon
Locknut	Zinc plated steel

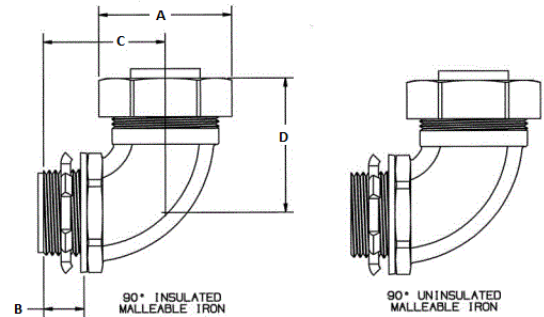

Performance

Environmental

Operating Temperature -60°F to +1000°F (-51°C to +538°C)

Online Resources

Customer Use Drawing
 eCatalog
 Installation Instructions

Dimensions in Inches (mm)

Hubbell Wiring Device-Kellems • Hubbell Incorporated (Delaware) • 40 Waterview Drive • Shelton, CT 06484

Phone (800) 288-6000 • Fax (800) 255-1031 • Specifications subject to change without notice.

