

Straight Blade Devices
 15A, 125V, 2 Pole, 3 Wire Grounding
 Heavy Duty Style Line® Decorator
 Receptacles

HUBBELL

Features

- Aesthetic Style Line® decorator design
- Triple wipe contacts

Ordering Information

Description	Device Color	UPC	Catalog Number
Back and side wired.	Office White	783585060385	HBL2152OW

Listings

UL Listed to UL498 File No. E2186
 Certified to CSA 22.2, No. 42 File 285
 Fed. Spec. W-C-596
 NEMA® WD-6 Compliant

Specifications

Face	Nylon
Base	PBT
Contacts	Brass
Wire Clamp	Plated brass
Terminal Screws	Brass
Mounting Strap	.040 in. (1) Galvanized steel
Automatic Self-grounding Staple	Stainless steel
Ground Contact	.031 in. (.8) Brass

Performance

Electrical	
Current Interrupting	Certified for current interrupting at full rated current
Dielectric Voltage	Withstands 2,000V minimum
Mechanical	
Product Identification	Ratings are a permanent part of the device
Terminal Accommodation	#14-#10 AWG copper stranded or solid conductor only
Terminal Identification	Terminals identified in accordance with UL 498 and CSA
Environmental	
Flammability	Top: UL 94V-2, Base: UL 94V-0
Operating Temperatures	Maximum continuous 75°C; minimum -40°C (w/o impact)

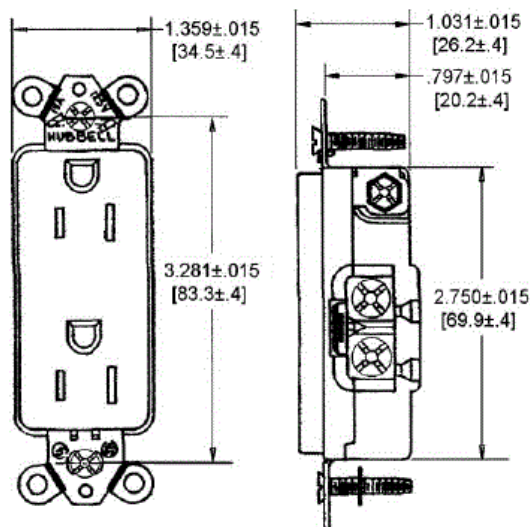

Accessories

Wallplate or Weatherproof Cover StyleLine® Decorator Opening

Resources

Customer Use Drawing
 eCatalog

Dimensions in Inches (mm)

Hubbell Wiring Device-Kellems • Hubbell Incorporated (Delaware) • 40 Waterview Drive • Shelton, CT 06484

Phone (800) 288-6000 • Fax (800) 255-1031 • Specifications subject to change without notice.

