

Twist-Lock® Devices  
 20A, 125V AC; 2 Pole, 3 Wire Grounding  
 Valise® Connector

# HUBBELL

## Features

- Unique patented clamp type terminals provide a superior electrical connection by “bundling” the conductor strands when clamps are tightened
- Totally insulated impact and crush resistant nylon body
- Powerful cord grip prevents conductor slippage and strain on wiring terminals



## Ordering Information

Description	Cord Diameter	UPC	Catalog Number
Yellow nylon.	.325" - .720" (8.26-18.3)	783585235653	HBL2323VY

## Listings

Listed to UL 498  
 Fed.Spec. W-C-596  
 Certified to CSA C22.2 No.42

## Specifications

Housing	Yellow nylon
Contacts	Brass
Terminal Screws	#8 - 32 Steel (Philips / Slotted / Robertson)
Terminal Clamps	Steel - Nickel plated
Clamp Screws	#8 - 32 Steel - Zinc plated (Philips / Slotted / Robertson)

## Performance

<b>Electrical</b>	
Current Interrupting	Certified for full rated current
Dielectric Voltage	Withstands 2,000V minimum
<b>Mechanical</b>	
Terminal Accommodation	#14 AWG- #8 AWG stranded copper wire only.
Terminal Identification	Terminals identified in accordance with UL 498
<b>Environmental</b>	
Flammability	HB or better per UL 94 or CSA 22.2 No. 0.6
Moisture Resistance	IP20 Suitability
Operating Temperature	Maximum continuous 75°C, minimum -40°C (w/o impact)

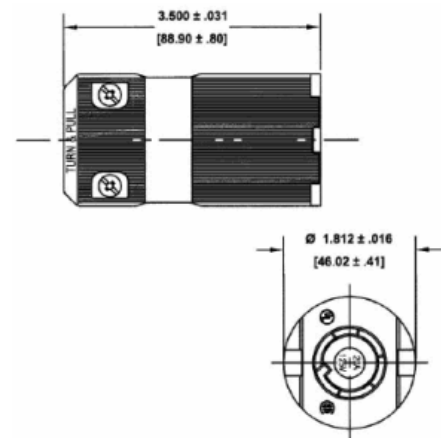

## Accessories

Plug	HBL2323VY
Plug	HBL2321VY
Flanged Inlet	HBL2326
Weatherproof Boot	HBL60CM32V

## Resources

Customer Use Drawing  
 eCatalog

Dimensions in Inches (mm)

Hubbell Wiring Device-Kellems • Hubbell Incorporated (Delaware) • 40 Waterview Drive • Shelton, CT 06484

Phone (800) 288-6000 • Fax (800) 255-1031 • Specifications subject to change without notice.

