

Hubbell Raceway
HBL2400 and HBL2400D Series
Transition Fitting



Features

- Uses HBL 2400 Series raceway and fitting and accessories to customize the install
- Scratch resistant finish
- For use upto 600V AC

Ordering Information

Accessory Type	Color	UPC Number
Transition Fitting	Ivory	783585341835

Listings

UL Standard UL 5
 E253976 /E253830 /E253833
 CSA Standard C22.2 no. 62

Specifications

Raceway Series	HBL2400 and HBL2400D Series
Material	Steel
Finish	Painted, Ivory

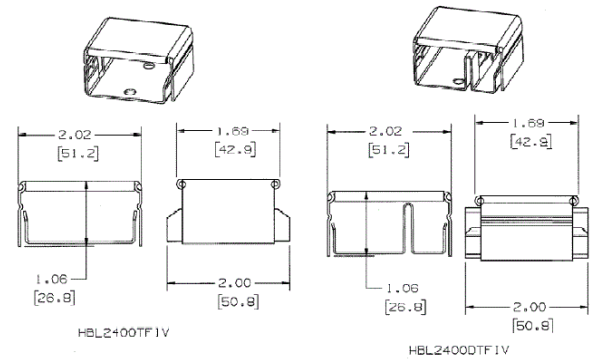

Related Products

Raceway Base and Cover	HBL2400BCIV
Raceway Base, Divided	HBL2400BDIV
Raceway Base	HBL2400BIV
Raceway Cover	HBL2400CIV

Online Resources

- Customer Sales Drawings
- eCatalog
- Installation Instructions

Dimensions in Inches (mm)

Hubbell Wiring Device-Kellems • Hubbell Incorporated (Delaware) • 40 Waterview Drive • Shelton, CT 06484

Phone (800) 288-6000 • Fax (800) 255-1031 • Specifications subject to change without notice.

