

Twist-Lock® Devices
 30A, 125V AC, 2 Pole, 3 Wire Grounding
 Single Flush Receptacle



Features

- Wire restraint recess for both back and side wiring, greatly reduces the possibility of loosening the terminal connection
- Face color coding by voltage facilitates locating and mating of proper devices
- All-brass mounting and grounding system provides a lower resistance ground path and greater resistance to corrosion than steel mounting systems

Ordering Information

Description	Device Color	UPC	Catalog Number
Nylon face, back and side wire.	Blue	783585454610	HBL2610M6



Listings

Listed to UL 498
 Fed.Spec. W-C-596
 Certified to CSA C22.2 No.42

Specifications

Face	Nylon
Base	Glass-Reinforced thermoplastic polyester (RTP)
Contacts	Brass
Terminal Screws	#10 - 32 Brass
Mounting Strap	Brass

Performance

Electrical	
Current Interrupting	Certified for current interrupting at full rated current
Dielectric Voltage	Withstands 2,000V minimum

Mechanical	
Terminal Accommodation	#16 AWG - #8 AWG solid or stranded copper wire only.

Terminal Identification	Terminals identified in accordance with UL 498
-------------------------	--

Environmental	
Flammability	V2 or better per UL94/CSA 22.2 No.0.17
Moisture Resistance	IP20 Suitability
Operating Temperatures	Maximum Continuous 75°C; Minimum -40°C (w/o impact)

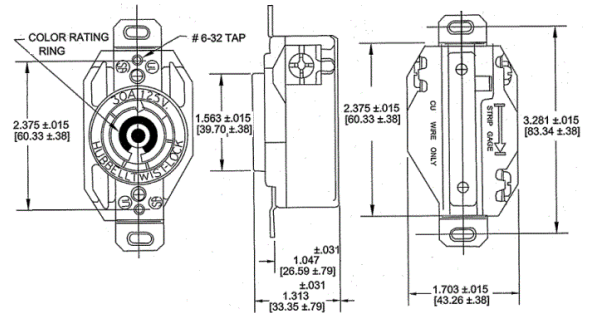

Accessories

Plug	HBL2611
Wallplate or Weatherproof Cover	1.60" Opening

Resources

eCatalog

Dimensions in Inches (mm)

Hubbell Wiring Device-Kellems • Hubbell Incorporated (Delaware) • 40 Waterview Drive • Shelton, CT 06484

Phone (800) 288-6000 • Fax (800) 255-1031 • Specifications subject to change without notice.

