

Twist-Lock® Devices

30A, 3 Phase Y 347/600V AC, 4 Pole, 4 Wire
Non-Grounding

Insulgrip® Plug

Features

- Ribbed nylon housing provides a secure grip and impact and chemical resistance.
- Superior cord grip design protects terminations from excess strain.
- Clear, funnel shaped wire entry for ease of termination.
- Integral dust shield protects wiring chamber from dust or contaminants.

Ordering Information

Description	Cord Diameter	UPC	Catalog Number
Black and white nylon.	.350"-1.150" (9-29)	783585039510	HBL2771

Listings

Listed to UL 498
Fed.Spec. W-C-596
Certified to CSA C22.2 No.42

Specifications

Housing / Cord Clamp	Nylon
Terminal Retainer	Clear polycarbonate
Blades	Brass
Terminal Screws	#10-32 Brass (Phillips / Slotted / Robertson)
Terminal Clamp	Cold rolled steel – nickel plated
Assembly Screws	Steel - nickel plated

Performance

Electrical	
Current Interrupting	Certified for current interrupting at full rated current

Dielectric Voltage	Withstands 2,000V minimum
--------------------	---------------------------

Mechanical

Terminal Accommodation	#16 AWG - #8 AWG stranded copper wire only.
Terminal Identification	Terminals identified in accordance with UL 498

Environmental

Flammability	HB or better per UL94/CSA 22.2 No.0.17
Moisture Resistance	IP20 Suitability
Operating Temperatures	Maximum Continuous 75°C; Minimum -40°C (w/o impact)

HUBBELL



30A 3ØY
347/600V AC
NEMA L20-30P
UL Listed

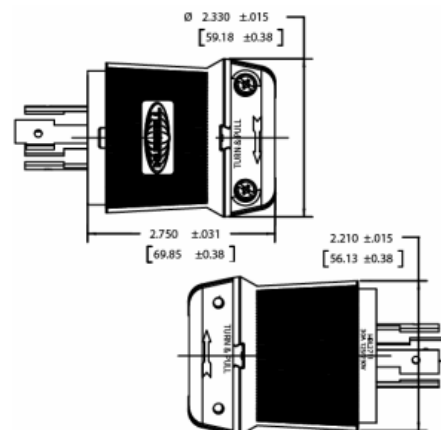

Complementary Products

Connector	HBL2773
Single Receptacle	HBL2770
Flanged Receptacle	HBL2776
Weatherproof Boot	HBL6035

Online Resources

Customer Use Drawing
eCatalog
Installation Instructions

Dimensions in Inches (mm)

Hubbell Wiring Device-Kellems • Hubbell Incorporated (Delaware) • 40 Waterview Drive • Shelton, CT 06484

Phone (800) 288-6000 • Fax (800) 255-1031 • Specifications subject to change without notice.

