

Watertight Devices

30A, 120/208V AC, 4 Pole, 5 Wire

Twist-Lock® Plug

HUBBELL

Features

- Smooth body design minimizes collection points simplifying the wash down process
- Strain relief nut always seals on the body, minimizing debris collection
- Stainless steel hardware and corrosion-resistant connection points

Ordering Information

Description	Cord Diameter	UPC Number	Catalog Number
Thermoplastic elastomer yellow plug	0.375"-1.000" (9.5-25.4)	783585131757	HBL28W81

Listings

IP69K rating
Listed to UL498
Certified to CSA C22.2 No. 42
Meets NEMA WD-1, WD-6 and ANSI standards
UL Listed, CSA Certified to Type 4, 4X, 12, 6, 6P

Specifications

Body	Thermoplastic Elastomer
Blade Holder	White Nylon
Terminal Retainer	Clear polycarbonate
Blades	Nickel plated brass
Core	White Nylon
Bushing & Cone Seal	Black Elastomer
Gotcha Ring	Nylon
Strain Relief Nut	PBT
Terminal Screws	Nickel Plated Brass

Performance

Electrical	
Current Interrupting	Rated for current interruption per UL498
Dielectric Voltage	2500V AC
Max Working Voltage	As marked
Temperature Rise	30°C max per UL498 at rated current

Mechanical

Cord Accomodation	0.375"-1.000" (9.5-25.4)
-------------------	--------------------------

Environmental

Moisture Resistance	UL Listed 4, 4X, 12, 6, 6P
Operating temperatures	-40°C (without impact) to +60°C continuous
UV resistance	All exposed materials are UV stabilized

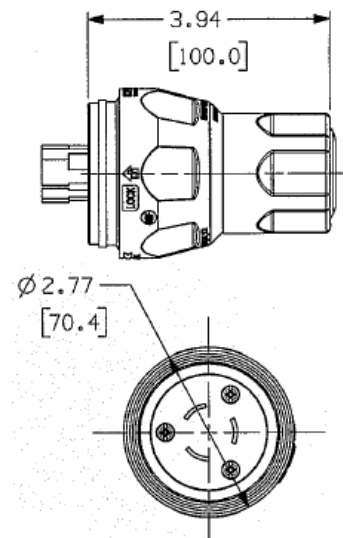

Complementary Products

Watertight Connector	HBL29W81
Watertight Receptacle with Lift Cover	HBL69W81

Online Resources

Customer Use Drawing
eCatalog
Installation Instructions

Dimensions in Inches (mm)

Hubbell Wiring Device-Kellems • Hubbell Incorporated (Delaware) • 40 Waterview Drive • Shelton, CT 06484

Phone (800) 288-6000 • Fax (800) 255-1031 • Specifications subject to change without notice.

