

**Hubbell Raceway**  
**HBL3000 Series**  
**End Cap**



**Features**

- Uses HBL 3000 Series raceway and fitting and accessories to customize the install
- Scratch resistant finish
- For use upto 600V AC

**Ordering Information**

Accessory Type	Color	UPC Number
End Cap	Ivory	783585215242

**Listings**

UL Standard UL 5  
 E253976 /E253830 /E253833  
 CSA Standard C22.2 no. 62

**Specifications**

Raceway Series	HBL3000 Series
Material	Steel
Finish	Painted, Ivory

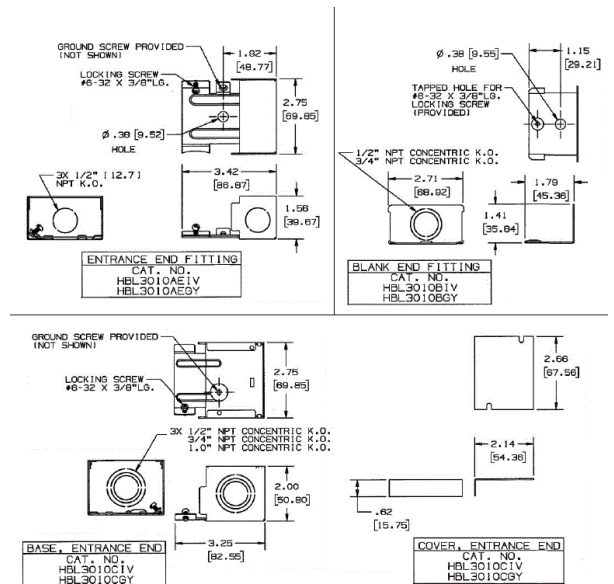

**Related Products**

Raceway Base	HBL3000BIV
Cover, 5'	HBL3000CEIV
Cover, 19.5"	HBL3000C195IV
Cover, 7.5"	HBL3000C075IV

**Online Resources**

- Customer Sales Drawings
- eCatalog
- Installation Instructions

Dimensions in Inches (mm)

Hubbell Wiring Device-Kellems • Hubbell Incorporated (Delaware) • 40 Waterview Drive • Shelton, CT 06484

Phone (800) 288-6000 • Fax (800) 255-1031 • Specifications subject to change without notice.

