

## IEC Pin and Sleeve

60A, 250V, 2 Pole, 3 Wire

## Watertight Receptacle

### Features

- UL Type 4X, 12 and IP69k environmental ratings
- Super tough insulated non-metallic housing
- Self-closing gasketed cover
- Sequential contact engagement to prevent a momentary over-voltage
- Market leading UL witnessed HP ratings

### Ordering Information

Description	UPC	Catalog Number
Watertight IEC Pin and Sleeve Receptacle	783585403861	HBL360R6W

### Listings

UL Classified, File E146032  
CSA Certified File LR285C  
Listed to standard UL1682

### Specifications

Housing	PBT
Closure Covers	PBT
Sealing Gasket	Solid Neoprene
Retainer	High-Impact Thermoset
Gaskets	Santoprene
Terminal Screws	Stainless Steel

### Performance

<b>Electrical</b>	
Current Interrupting	Certified for current interrupting at full rated current
Dielectric Voltage	Withstand 3000V AC
Max. Working Voltage	600V AC RMS
<b>Mechanical</b>	
Impact Resistance	Per CSA C22.2 No. 182.1 / UL1682
Product Identification	Identification and ratings are a permanent part of the device housing
Terminal Identification	Terminals identified in accordance with North American and IEC conventions
<b>Environmental</b>	
Flammability	V-0
Ingress Protection	TYPE 3R,3RX,4X and IP68,IP69K
Moisture Resistance	IEC 60309-1
Operating Temperatures	Maximum Continuous 75°C; Minimum - 40°C w/o impact

### Complementary Products

Cover Assemblies

# HUBBELL

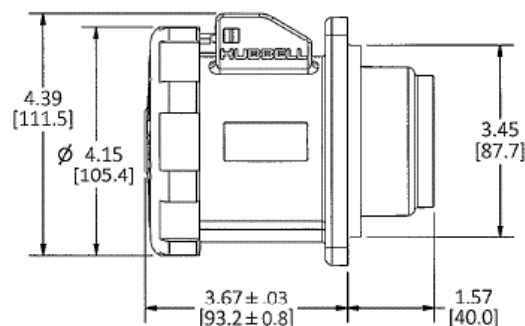

Dimensions in Inches (mm)

Hubbell Wiring Device-Kellems • Hubbell Incorporated (Delaware) • 40 Waterview Drive • Shelton, CT 06484

Phone (800) 288-6000 • Fax (800) 255-1031 • Specifications subject to change without notice.

