

IEC Pin and Sleeve

60A, 480V, 2 Pole, 3 Wire

Watertight Receptacle

Features

- UL Type 4X, 12 and IP69k environmental ratings
- Super tough insulated non-metallic housing
- Self-closing gasketed cover
- Sequential contact engagement to prevent a momentary over-voltage
- Market leading UL witnessed HP ratings

Ordering Information

Description	UPC	Catalog Number
Watertight IEC Pin and Sleeve Receptacle	783585403878	HBL360R7W

Listings

UL Classified, File E146032
CSA Certified File LR285C
Listed to standard UL1682

Specifications

Housing	PBT
Closure Covers	PBT
Sealing Gasket	Solid Neoprene
Retainer	High-Impact Thermoset
Gaskets	Santoprene
Terminal Screws	Stainless Steel

Performance

Electrical	
Current Interrupting	Certified for current interrupting at full rated current
Dielectric Voltage	Withstand 3000V AC
Max. Working Voltage	600V AC RMS
Mechanical	
Impact Resistance	Per CSA C22.2 No. 182.1 / UL1682
Product Identification	Identification and ratings are a permanent part of the device housing
Terminal Identification	Terminals identified in accordance with North American and IEC conventions
Environmental	
Flammability	V-0
Ingress Protection	TYPE 3R,3RX,4X and IP68,IP69K
Moisture Resistance	IEC 60309-1
Operating Temperatures	Maximum Continuous 75°C; Minimum - 40°C w/o impact

Complementary Products

Cover Assemblies

HUBBELL

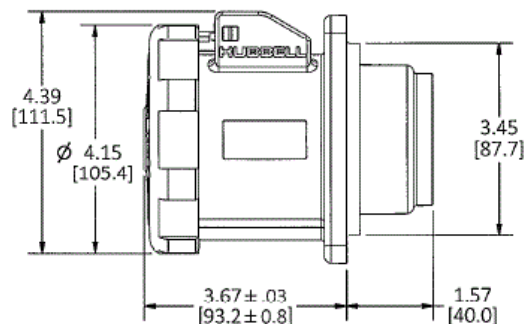

Dimensions in Inches (mm)

Hubbell Wiring Device-Kellems • Hubbell Incorporated (Delaware) • 40 Waterview Drive • Shelton, CT 06484

Phone (800) 288-6000 • Fax (800) 255-1031 • Specifications subject to change without notice.

