

## IEC Pin and Sleeve

20A, 3 Phase 250V, 3 Pole, 4 Wire

## Watertight Connector Body

### Features

- Self-closing gasketed cover
- Super tough insulated non-metallic housing
- Watertight neoprene glad seal to prevent water ingress from entering at cable entrance
- Sequential contact engagement to prevent a momentary over-voltage
- Multi contact spring provides and maintains high unit pressure on mating pins to minimize temperature rise

### Ordering Information

Description	UPC	Catalog Number
Watertight IEC Pin and Sleeve Connector Body	783585403892	HBL363C6W

### Listings

UL Listed, File E146033  
CSA Certified File LR280C  
UL Classified to IEC 60309-1 IEC 60309-2

### Specifications

Housing	PBT
Cord Clamps	PBT
Glands	Solid Neoprene
Covers	PBT
Gaskets	Santoprene

### Performance

<b>Electrical</b>	
Current Interrupting	Certified for current interrupting at full rated current
Dielectric Voltage	Withstand 3000V AC
Max. Working Voltage	600V RMS
<b>Mechanical</b>	
Impact Resistance	Per CSA C22.2 No. 182.1 / UL1682
Product Identification	Identification and ratings are a permanent part of the device housing
Terminal Identification	Terminals identified in accordance with North American and IEC conventions
<b>Environmental</b>	
Flammability	V-0
Ingress Protection	TYPE 3R,3RX,4X AND IP68,IP69K
Moisture Resistance	IEC 60309-1
Operating Temperatures	Maximum Continuous 75°C; Minimum - 40°C w/o impact

### Complementary Products

Cover Assemblies  
Cord Clamp and Locking Ring  
Liquidtight Adapters

### Online Resources

Customer Sales Drawing  
eCatalog  
Installation Instructions

# HUBBELL

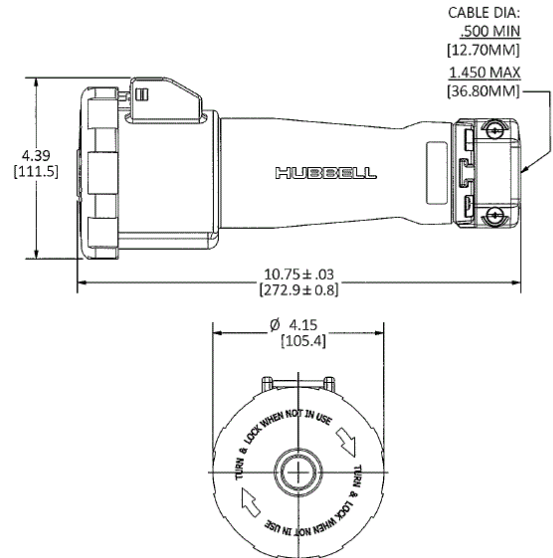

Dimensions in Inches (mm)

Hubbell Wiring Device-Kellems • Hubbell Incorporated (Delaware) • 40 Waterview Drive • Shelton, CT 06484

Phone (800) 288-6000 • Fax (800) 255-1031 • Specifications subject to change without notice.

