

IEC Pin and Sleeve

30A, 3 Phase, 480V, 3 Pole, 4 Wire

Watertight Plug

Features

- One piece non-metallic housing provides impact and chemical resistance in an insulated body
- Solid one-piece pins for reliable electrical contact
- Gasketed sealing ring provides watertight seal
- Heavy duty external cord grips for maximum cord retention

Ordering Information

Description	UPC	Catalog Number
Watertight IEC Pin and Sleeve Mating Plug	783585403908	HBL363P6W

Listings

UL Listed, File E146032
CSA Standard C22.2 No. 182.1
UL Classified to IEC60309-1

Specifications

Housing	PBT
Locking Ring	PBT
Sealing Gasket	Solid Neoprene
Retainer	High-Impact Thermoset
Terminal Screws	Stainless Steel

Performance

Electrical	
Current Interrupting	Certified for current interrupting at full rated current
Dielectric Voltage	Withstands 3,000V AC Min
Max. Working Voltage	600V AC RMS
Mechanical	
Impact Resistance	Per CSA C22.2 No.182.1 /UL1682
Product Identification	Identification and ratings are a permanent part of the device housing.
Terminal Identification	Terminals identified in accordance with North American and IEC conventions
Environmental	
Flammability	V-0
Ingress Protection	3R,3RX,4X,IP68,IP69K
Moisture Resistance	IEC 60309-1
Operating Temperature	Maximum Continuous 75°C; Minimum - 40°C w/o impact

Complementary Products

Closure Cap
Cord Clamp and Locking Ring
Liquidtight Adapters

Online Resources

Customer Sales Drawing
eCatalog
Installation Instructions

HUBBELL

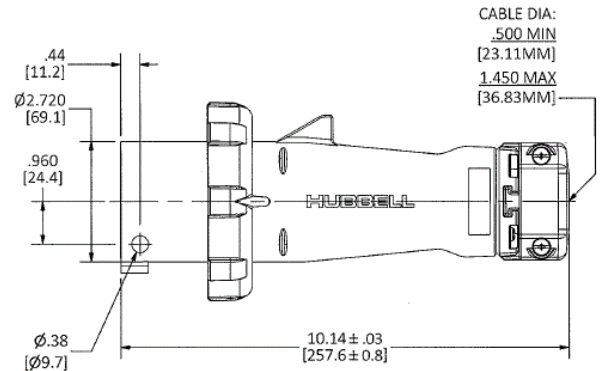

Dimensions in Inches (mm)

Hubbell Wiring Device-Kellems • Hubbell Incorporated (Delaware) • 40 Waterview Drive • Shelton, CT 06484

Phone (800) 288-6000 • Fax (800) 255-1031 • Specifications subject to change without notice.

