

Twist-Lock® Devices
 50A, 250V DC, 600V AC, 3 Pole, 4 Wire
 Grounding
 Flanged Inlet

HUBBELL

Features

- Metallic flanged casing provides maximum strength and protection
- Thermoset interior provides superior heat resistance

Ordering Information

Description	Device Style	UPC	Catalog Number
Zinc plated steel casing, thermoset interior	Metallic	783585236483	HBL3775

Listings

Listed to UL 498
 Certified to CSA C22.2 No.42

Specifications

Casing	Steel, zinc plated
Terminal Retainer	Phenolic
Blades	Brass
Terminal Screws	Steel

Performance

Electrical

Current Interrupting Certified for current interrupting at full rated current
 Dielectric Voltage Withstands 2,000V minimum

Mechanical

Terminal Accommodation #10 AWG - #6 AWG solid or stranded copper wire only

Environmental

Flammability UL 94 V0
 Operating Temperatures Maximum continuous 75°C; minimum -40°C (w/o impact)

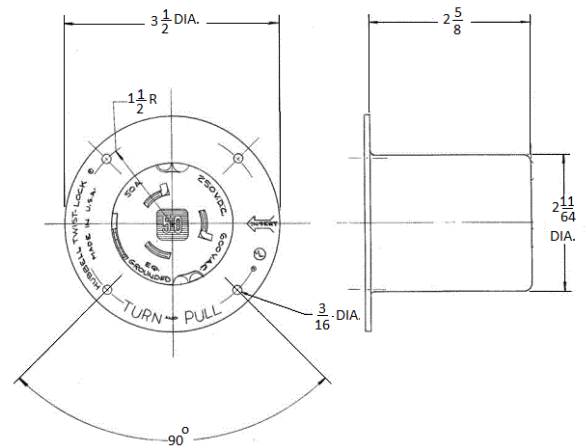

Accessories

Connector	HBL3764C
-----------	----------

Resources

Customer Use Drawing
 eCatalog

Dimensions in Inches (mm)

Hubbell Wiring Device-Kellems • Hubbell Incorporated (Delaware) • 40 Waterview Drive • Shelton, CT 06484

Phone (800) 288-6000 • Fax (800) 255-1031 • Specifications subject to change without notice.

