

IEC Pin and Sleeve

100A, 3Phase, 480V, 3 Pole, 4 Wire

Watertight Connector Body

Features

- UL Type 4X, 12 and IP69k environmental ratings
- Impact and corrosion resistant insulated non-metallic housing
- Watertight neoprene glad seal to prevent water ingress from entering at cable entrance
- Sequential contact engagement to prevent a momentary over-voltage
- Market leading UL witnessed HP ratings

Ordering Information

Description	UPC	Catalog Number
Watertight IEC Pin and Sleeve Connector Body	783585403991	HBL4100C7W

Listings

UL Listed, File E146033
CSA Certified File LR280C
UL Classified to IEC 60309-1 IEC 60309-2

Specifications

Housing	PBT
Cord Clamps	PBT
Glands	Solid Neoprene
Covers	PBT
Gaskets	Santoprene

Performance

Electrical	
Current Interrupting	Certified for current interrupting at full rated current
Dielectric Voltage	Withstand 3000V AC
Max. Working Voltage	600V RMS
Mechanical	
Impact Resistance	Per CSA C22.2 No. 182.1 / UL1682
Product Identification	Identification and ratings are a permanent part of the device housing
Terminal Identification	Terminals identified in accordance with North American and IEC conventions
Environmental	
Flammability	V-0
Ingress Protection	Type 3R, 3RX, 4X and IP68, IP69K
Moisture Resistance	IEC 60309-1
Operating Temperatures	Maximum Continuous 75°C; Minimum - 40°C w/o impact

Complementary Products

Cover Assemblies
Cord Clamp and Locking Ring
Liquidtight Adapters

Online Resources

Customer Sales Drawing
eCatalog
Installation Instructions

HUBBELL

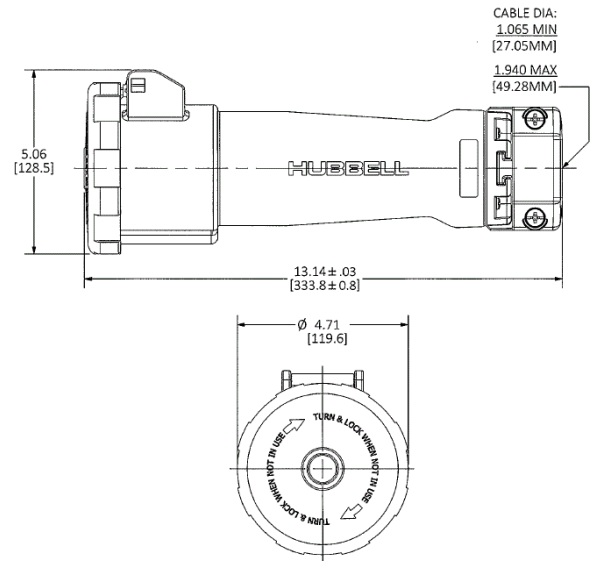

Dimensions in Inches (mm)

Hubbell Wiring Device-Kellems • Hubbell Incorporated (Delaware) • 40 Waterview Drive • Shelton, CT 06484

Phone (800) 288-6000 • Fax (800) 255-1031 • Specifications subject to change without notice.

