

UL 1686 C1 Pin and Sleeve

200A, 600/250V AC/DC, 3 Pole, 4 Wire

Reversed Service Insulgrip® Plug

Features

- Beryllium copper spring maintains high unit pressure on mating sleeves
- Locking ring provides UL Type 4X watertight, dust-tight seal
- Catalog number and rating visible while in use
- Pin chamber confines arcing within the interior chamber



Ordering Information

Description Watertight Insulgrip Plug, Reversed Service	UPC 783585012308	Catalog Number HBL4200PS1WR
Device Color Aluminum	Grounding Style Style 1	

Standards

UL Standard 1682, UL 50, and UL 1010
CSA Certified to CSA Spec. C22.2 No. 159
UL Listed and CSA Certified Type 4X

Specifications

Housing	Valox® 357
Plug Shroud	Aluminum
Clamp Nut	Nickel Plated Brass
Gland Cap	Rynite® SST35
Retainer	Thermoset Polyester
O-Ring, Gaskets & Seals	Neoprene

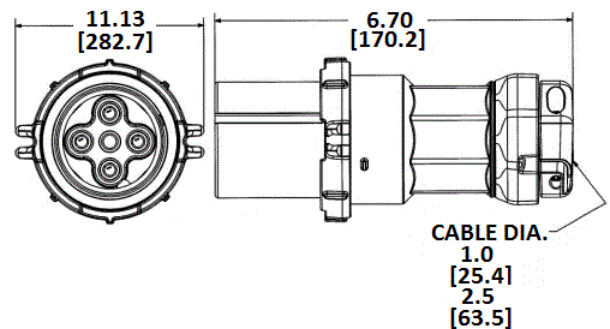

Performance

Electrical	
Current Interrupting	Certified for current interrupting at full rated current
Dielectric Voltage	Withstands 3,000V AC
Max. Working Voltage	600V AC RMS
Mechanical	
Impact Resistance	Per CSA C22.2, No. 182.1, UL 1682
Product Identification	Identification and ratings are permanently fastened to the device housing
Terminal Identification	Terminals identified in accordance with UL 1686(1, 2, 3, Green)
Environmental	
Flammability (Enclosure)	UL 94V-0 and CSA C22.2 No. 0.17
Moisture Resistance	Type 3, 4, 4X per UL 50E and CSA 22.2, No. 94
Operating Temperatures	Max. Continuous 75°C; Min. -40°C w/o impact -25° with impact

Online Resources

Customer Use Drawing
eCatalog
Installation Instructions

Dimensions in Inches (mm)

Hubbell Wiring Device-Kellems • Hubbell Incorporated (Delaware) • 40 Waterview Drive • Shelton, CT 06484

Phone (800) 288-6000 • Fax (800) 255-1031 • Specifications subject to change without notice.

HUBBELL

