

## UL 1686 C1 Pin and Sleeve

200A, 600/250V AC/DC, 3 Pole, 4 Wire

## Insulgrip® Pin and Sleeve Plug

### Features

- Impact resistant shroud protects sleeves from bending and breaking
- Locking ring provides UL Type 4X watertight, dust-tight seal
- Catalog number and rating visible while in use
- All-Brass sleeve contacts provide reliable electrical contact

### Ordering Information

<b>Description</b> Pin and Sleeve, Watertight Insulgrip Plug	<b>UPC</b> 783585011424	<b>Catalog Number</b> <b>HBL4200PS1W</b>
<b>Device Color</b> Aluminum	<b>Grounding Style</b> Style 1	

### Standards

UL Standard 1682, UL 50, and UL 1010  
CSA Certified to CSA Spec. C22.2 No. 159  
UL Listed and CSA Certified Type 4X

### Specifications

Housing	Valox® 357
Plug Shroud	Aluminum
Clamp Nut	Nickel Plated Brass
Gland Cap	Rynite® SST35
Retainer	Thermoset Polyester
O-Ring, Gaskets & Seals	Neoprene

### Performance

<b>Electrical</b>	
Current Interrupting	Certified for current interrupting at full rated current
Dielectric Voltage	Withstands 3,000V AC
Max. Working Voltage	600V AC RMS
<b>Mechanical</b>	
Impact Resistance	Per CSA C22.2, No. 182.1, UL 1682
Product Identification	Identification and ratings are permanently fastened to the device housing
Terminal Identification	Terminals identified in accordance with UL 1686(1, 2, 3, Green)
<b>Environmental</b>	
Flammability (Enclosure)	UL 94V-0 and CSA C22.2 No. 0.17
Moisture Resistance	Type 3, 4, 4X per UL 50E and CSA 22.2, No. 94
Operating Temperatures	Max. Continuous 75°C; Min. -40°C w/o impact -25° with impact

### Accessories

Cord Clamps and Locking Ring  
Liquidtight Adapters

### Online Resources

Customer Use Drawing  
eCatalog  
Installation Instructions

# HUBBELL

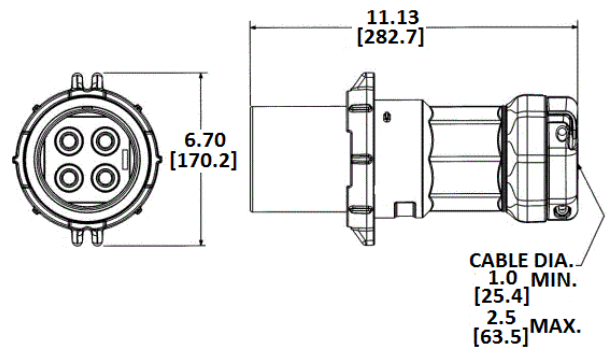

Dimensions in Inches (mm)

Hubbell Wiring Device-Kellems • Hubbell Incorporated (Delaware) • 40 Waterview Drive • Shelton, CT 06484

Phone (800) 288-6000 • Fax (800) 255-1031 • Specifications subject to change without notice.

