

UL 1686 C1 Pin and Sleeve

30A, 600/250V AC/DC, 3 Pole, 4 Wire

Reversed Service Insulgrip® Connector

Features

- O - Ring seal provides a watertight and dust tight seal, prevents contamination from entering wire chamber
- Closure cap with neoprene gasket for 4X watertight seal when not in use
- Lid - Stay allows for a hands free means of holding the cover in the open position
- All-Brass sleeve contacts provide reliable electrical contact



Ordering Information

Description	UPC	Catalog Number
Watertight Insulgrip Connector, Reversed Service	783585012353	HBL430CS2WR
Device Color	Grounding Style	
Aluminum	Style 2	

Standards

UL Standard 1682
CSA Certified to CSA Spec. C22.2 No. 182.1
UL Listed and CSA Certified Type 4X

Specifications

Housing	Valox® 357
Connector Shroud	Epoxy Painted Aluminum
Cord Clamps	Rynite® SST35
Clamp Nut	Nickel Plated Brass
Gland	Neoprene

Performance

Electrical	
Current Interrupting	Certified for current interrupting at full rated current
Dielectric Voltage	Withstands 3,000V AC
Max. Working Voltage	600V AC RMS
Mechanical	
Impact Resistance	Per CSA C22.2, No. 182.1, UL 1682
Product Identification	Identification and ratings are permanently fastened to the device housing
Terminal Identification	Terminals identified in accordance with UL 1686(1, 2, 3, Green)
Environmental	
Flammability (Enclosure)	UL 94V-0 and CSA C22.2 No. 0.17
Moisture Resistance	Type 3, 4, 4X per UL 50E and CSA 22.2, No. 94
Operating Temperatures	Max. Continuous 75°C; Min. -40°C w/o impact -25° with impact

Accessories

Cord Clamps and Locking Ring

Online Resources

Customer Use Drawing
eCatalog
Installation Instructions

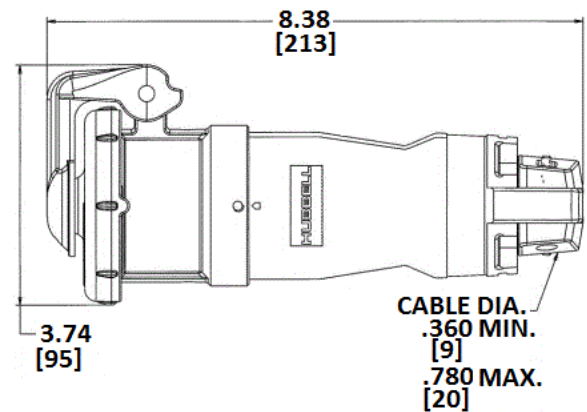

Dimensions in Inches (mm)

Hubbell Wiring Device-Kellems • Hubbell Incorporated (Delaware) • 40 Waterview Drive • Shelton, CT 06484

Phone (800) 288-6000 • Fax (800) 255-1031 • Specifications subject to change without notice.

HUBBELL

