

## IEC Pin and Sleeve

30A, 3 Phase, 240V, 3 Pole, 4 Wire

## Mechanical Interlock

### Features

- Plug cannot be removed until the switch is turned off.
- Large gears enclosed in a gear box
- Lockable handle to meet OSHA Lockout/Tagout regulations.
- Pre-wired IEC Pin and Sleeve receptacle
- Enclosure Type 4X, 12 and IP67 Suitability

### Ordering Information

Description	UPC	Catalog Number
Circuit-Lock® Pin and Sleeve Mechanical Interlock	783585405988	HBL430MI9W

### Color code

Blue

### Standards

UL Listed  
CSA Certified

### Specifications

Face	Valox®
Base	Valox®
Enclosure Gasket	Neoprene
Shaft Seal	Neoprene
Conduit Hub	Zinc

### Performance

Electrical	
Current Interrupting	Certified for current interrupting at full rated current and voltage
Dielectric Voltage	Withstands 3,000V AC Min
Max. Working Voltage	600V AC RMS

### Mechanical

Impact Resistance	In accordance with UL 746C
Mounting	External adjustable feet
Product Identification	Identification and ratings are part of the external label and molded into the receptacle mount
Terminal Identification	In accordance with UL, CSA and international conventions

### Environmental

Flammability	UL94-5VA and V-0 Classification
Ingress Protection	IP67 Suitability
Moisture Resistance	Outdoor - 4X (Watertight, Washdown); Indoor - 12 (Dust-tight, Falling Dirt and Noncorrosive Liquids).
Operating Temperature	Max. Continuous +75°C; Min. Continuous -40°C

### Online Resources

Customer Use Drawing  
eCatalog  
Installation Instructions

# HUBBELL

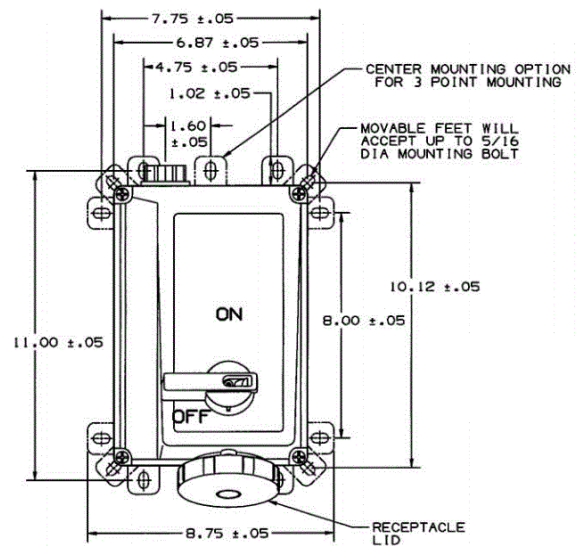

Dimensions in Inches (mm)

Hubbell Wiring Device-Kellems • Hubbell Incorporated (Delaware) • 40 Waterview Drive • Shelton, CT 06484

Phone (800) 288-6000 • Fax (800) 255-1031 • Specifications subject to change without notice.

