

Non-NEMA Twist-Lock® Devices
 30A, 250V DC Max. and 600V AC Max. 50- 400
 Hz 4 Pole, 5 Wire Grounding
 Variload® Receptacle

HUBBELL

Features

- Heat resistant thermoset construction
- Non-interchangeable center slot configuration to be designated to different circuits

Ordering Information

Description	Device Color	UPC	Catalog Number
4P5W, 30A 600V AC Max, Non-NEMA, Black Urea Face	Black	783585236537	HBL45205

Listings

Listed to UL 498
 Certified to CSA C22.2 No.42

Specifications

Housing	Molded Thermoset
Base	Molded thermoset
End Plate	Cold rolled steel
Strap	Brass
Contact Spring	Brass
Mounting Screw	Steel, zinc plated

Performance

Electrical	
Current Interrupting	Certified for current interrupting at full rated current
Dielectric Voltage	Withstands 2,000V minimum
Mechanical	
Terminal Accommodation	#14 AWG - #10 AWG solid or stranded copper wire only.
Terminal Identification	Terminals identified in accordance with UL 498
Environmental	
Flammability	V0 per UL94 or CSA 22.2 No.0.17
Operating Temperatures	Maximum Continuous 75°C; Minimum -40°C (w/o impact)

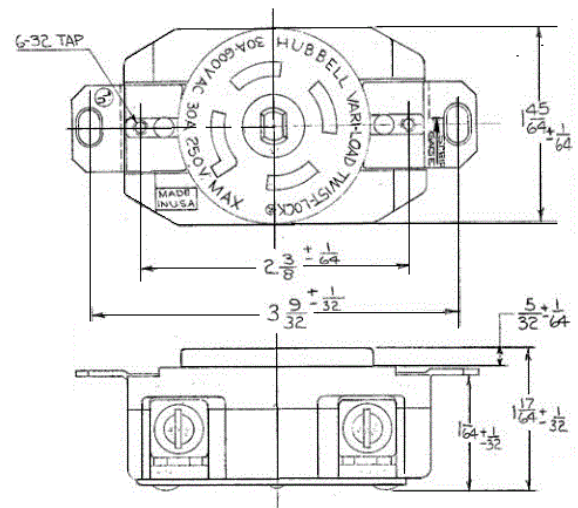

Accessories

Plug HBL45215
 Wallplate or Weatherproof Cover 1.74" Opening

Resources

Customer Use Drawing
 eCatalog

Dimensions in Inches (mm)

Hubbell Wiring Device-Kellems • Hubbell Incorporated (Delaware) • 40 Waterview Drive • Shelton, CT 06484

Phone (800) 288-6000 • Fax (800) 255-1031 • Specifications subject to change without notice.

